

Complete 47-piece Polaroid "800" Outfit gives you finished prints in 10 seconds

Reduced \$70

Was ~~\$158.88~~ **\$88.88** cash **NO MONEY DOWN**



47 pieces plus 10-year Camera Guarantee*

Now, take advantage of all the latest developments from Polaroid and save money too! Polaroid pictures are better than ever . . . and so easy to take. Get everything you'll need to take them . . . and to cherish them for years.

Take it with the "800" camera and admire your finished print 60 seconds later! The exposure value (EV) system is the key to easy picture-taking. Just dial a single EV number and you automatically get correct lens and shutter settings. Sight and focus through the coupled rangefinder-viewfinder. Capture your subject with perfect definition at every distance from 3½ feet to infinity with the sharp 3-element lens. Take eight large 3¼x4¼-inch prints per roll.

Aluminum body has special reinforcement at wear points and lifetime lubricated bearings. All camera parts guaranteed against defects in materials and workmanship for 10 years from date of original purchase . . . any such defects will be remedied *without charge* at factory authorized repair stations.

Wink-light attachment lets you take flattering indoor pictures without costly flash bulbs. In extremely dim light take regular flash pictures with AG1 booster attachment that plugs into Wink-light. A single battery (included) gives over 1000 winks. 4-S filter lets you take pictures in brightest sunlight with 3000 film . . . the same film you use indoors, without flash. Carry the camera and accessories in the custom-fitted case of top-grain cowhide with adjustable shoulder strap. Eight rolls of fast Polaroid 3000 film included . . . take 64 big pictures.

Learn how to use the Polaroid camera at its creative best from the informative, easy-to-read "pictures in a minute" book . . . hard covers, 96 pages. Jumbo 5½x11½-inch album with artificial leather cover, has transparent pockets for 90 prints. Keep 32 more prints in two handy pocket-size albums. Postcarders are self-adhesive for attaching a Polaroid print.

You get 25 Postcarders in the outfit. Also 6 coupons redeemable for 6 beautiful 5x7-inch enlargements in display folders. (Valid when submitted with an order for regular Polaroid reprint service.) Gift boxed.

3 CA 9734C—Complete "800" Outfit. Shpg. wt. 13 lbs. \$88.88

***Camera guarantee**

All camera parts guaranteed for 10 years from date of original purchase against defects in materials. Any such defects shall be remedied by authorized repair shops without charge to customer.

NO MONEY DOWN . . . See page 63 for Sears Easy Terms

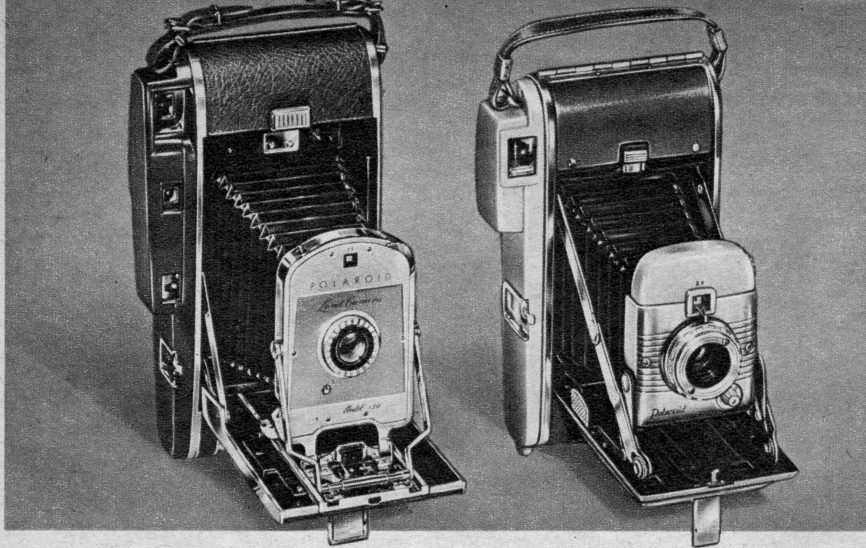

Polaroid "150"

Polaroid "80B"

Camera only \$93.45 cash NO MONEY DOWN

Camera only

Big 3¼x4¼-inch prints in just 10 seconds! Parallax corrected finder gives you accurate viewing close or far away. Coupled range-finder. Adjust shutter speed and lens opening with single dial. Aluminum body. Brown simulated leather cover and hand strap.
3 CA 9743C—High Speed Outfit. (Outfit described at right below.)
Shipping weight 11 pounds.....\$119.95
3 CA 9562C—Camera only. Wt. 6 lbs.. 93.45

You get 2¾x3½-in. prints in 10 seconds with compact Polaroid, the smallest, easiest-to-focus optical viewfinder. Easy-to-adjust dial for shutter speed. Wink-light for flash attachment. Aluminum body. Brown simulated leather cover. Comes with High Speed Outfit (described below).
Shipping weight 9 pounds.....\$119.95
—Camera only. Shpg. wt. 4 lbs..

SORRY—NOT AVAILABLE

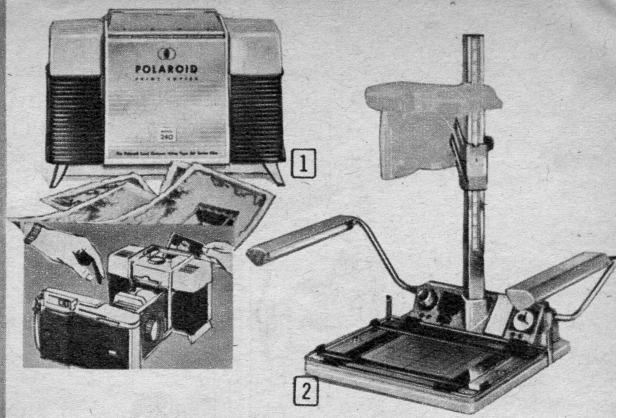

Have copies in 10 seconds of photos or documents

1 Polaroid Print Copier. Now you can have copies of Polaroid pictures. Polaroid copier gives clear prints quickly, easily, for pennies apiece. No messy chemicals.

You get a perfect copy in just 10 seconds, as quickly as you got your original picture. The copier's electric timer assures exact exposure. In fact, because exposure is controlled, your copy may even be an improvement over the original! Polarized lights provide even, glareless illumination and a top quality lens brings every copy into perfect focus. 110-120-volt AC only. UL listed.

3 CA 9631—Model 230. For all 80 series models (3¼x2¼-in. prints). Shipping weight 4 lbs.....\$28.44
3 CA 9632—Model 240. For 95, 95A, 95B, 700, 150 and 800 (3¼x4¼-in. prints). Shipping weight 5 lbs.....\$28.44
3 CA 9633—Model 241. For 110, 110A (3¼x4¼). Wt. 4 lbs. 28.44

2 Polaroid Copymaker Model 208. When you need 10-second prints of charts, maps, documents, small objects, the Copymaker provides them. Easel with four sliding masks holds anything that will fit into an 11x14-inch space. Easel masked in 8 field sizes so you know what will be included in the picture when camera is in different positions. Built-in timer measures exposure and development.

Uniform lighting comes from 2 fluorescent lights, one on each side of the easel.

Model 208 fits all Polaroid Land Cameras using 40 series (3¼x4¼-inch) film. After using the Copymaker, make extra prints with the Polaroid print copier, described above. Perfect when fast, exact copies are required. 110-120-volt AC.
3 CA 9634K—Model 208. Shipping weight 24 lbs.....\$95.50

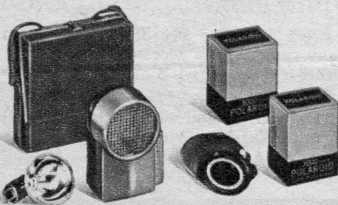

Take Polaroid pictures indoors without flash! Here's what you get in each High Speed Outfit:
✓ Polaroid Land Camera, either "150" or "80B" model.
✓ Plastic compartment case for camera.
✓ Wink-light with booster flash attachment.
✓ 4-S filter for using 3000 film outdoors.
✓ 2 rolls of ultra-fast Polaroid 3000 film.

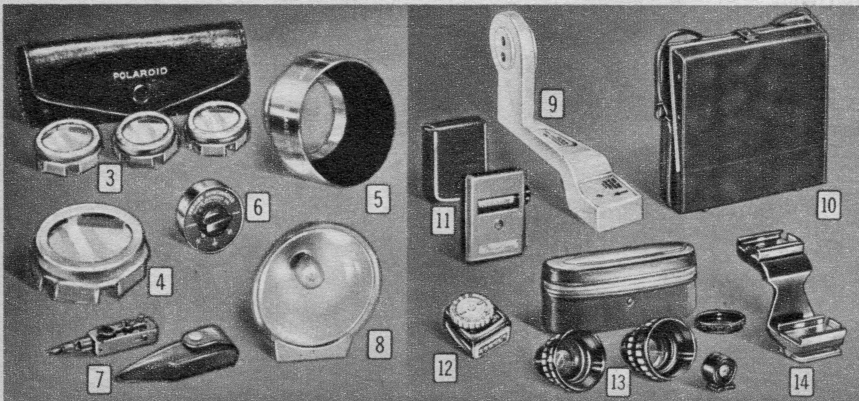

Accessories for Polaroid Cameras

- 3 Filter Kit. Orange and half step and polarizing filters. Case. Shpg. wt. 1 lb.
3 CA 9639—For all models except 110A. \$4.95
- Close-up Kit (not shown). For portraits, photocopying. 3 lenses, case. Shpg. wt. 1 lb.
3 CA 9638—For all models except 110A. \$7.45
- 4 Orange Filter. Fits all but 110A.
3 CA 9572—Shipping wt. 3 oz. 1.87
- 5 Lens Shade. Fits all but 110A.
3 CA 9573—Shpg. wt. 3 oz. 2.37
- 6 Minitimer with bell. Wt. 8 oz.
3 CA 9607—Attaches to camera... \$3.95
- 7 Self-timer. Make self portraits. Gives 10-second delay. Leather case.
3 CA 9618—Shipping wt. 6 oz. \$2.95
- 8 Shoe Synch Flashgun. For all Polaroids except 95's. Safety shield.
3 CA 9613—With BC battery. Wt. 1 lb.. \$4.95
- 9 Bounce-flash Bracket. Clips to camera.
3 CA 9559—For 95B. Wt. 4 oz. \$1.69
3 CA 9560—For 150, 110A, 80A. Wt. 3 oz. 2.79
- 10 Plasticized Artificial Leather Case. Compartments for camera, accessories. Brown with satin aluminum trim; shoulder strap.
3 CA 8397—10x3¼x9 in. For models 80, 80A and 80B. Shipping weight 3 lbs..... \$7.25
3 CA 8396—11¼x3¼x10¼ in. For models 150, 110A, 800 and 95B. Shpg. wt. 3 lbs. 8 oz. 7.75
- 11 Exposure Meter. Gives direct reading. For Polaroid film including 3000 type. With case.
3 CA 9612—Shipping weight 8 oz. \$7.95
- 12 High Speed Polaroid Meter, to ASA 12,000.
3 CA 9557—Shipping weight 6 oz. \$14.95
- 13 Lens Set. Telephoto and wide angle lenses, with adapter. Includes finder and lens hoods. Fits all models except 110's. Leather case.
3 CA 9617—Shipping weight 1 lb. 2 oz. \$29.95
- 14 Accessory Bracket. Mounts in camera accessory clip. Allows you to use finder (above) and Wink-light or use meter and Wink-light, etc. at same time. Accessory bracket fits all Polaroid cameras except 95, 95A and 95B.
3 CA 9616—Shipping weight 2 oz. \$3.49

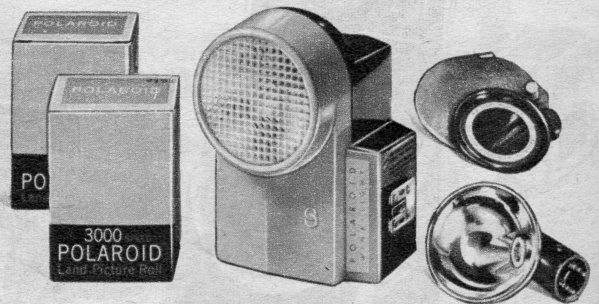

Polaroid Films and Wink-light

Polaroid 3000 Film is 15 times more sensitive than standard Polaroid films; lets you take indoor shots with window or regular room light. You still get a print in 10 seconds. Wink-light recommended for best indoor results. Outdoors, use with 4-S filter.

Type 37 (2¾x3½-in. prints). 8 exposures. For 80 series.
3 CA 9552—Shipping wt. each 8 oz. \$1.49; 3 rolls \$4.33
Type 47 (3¼x4¼-in. prints). 8 exp. For all except 80 series.
3 CA 9553—Shipping wt. each 8 oz. \$1.89; 3 rolls \$5.47

Panchromatic Films. 8 exposures.

Catalog No.	Regular Type	Exp. Index	Roll	3 Rolls
For models 150, 800, 110A, 95's. 3¼x4¼ in. Wt. each 8 oz.				
3 CA 9565	42 Pan	200	\$1.79	\$5.22
3 CA 9566	44 Pan	400	1.97	5.79

For model 80's. 2¾x3½ in. Shpg. wt. each 8 oz.
3 CA 9561 | 32 Pan | 400 | \$1.39 | \$3.99

Polaroid Wink-light, used with Polaroid 3000 film, lets you take indoor shots without flash bulbs. Comes with booster flash attachment for extra power. Takes 1000 shots on 1 battery and bulb set (included). Also includes 4-S filter for using 3000 film outdoors. Shpg. wt. 1 lb. 4 oz.
3 CA 9554—For 80's, 150, 800 and 110A. \$14.77
3 CA 9555—For all 95's, 100 and 700. 14.77
3 CA 9735—Extra Battery and Bulb Set. Wt. 10 oz. ... 1.95

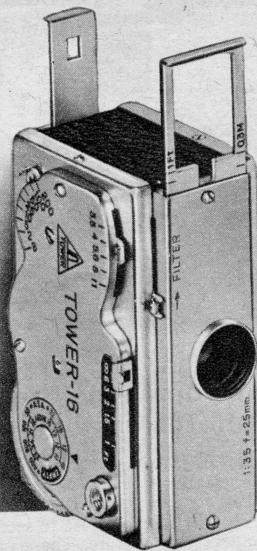

Now . . . never be without a camera . . . TOWER 16 fits in your pocket

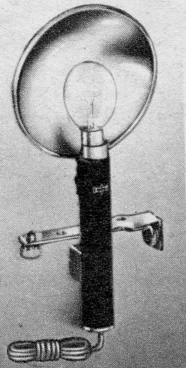

Camera and case only **\$2920** cash **NO MONEY DOWN**

Just think . . . how many times have you missed that "shot of a lifetime" because your camera was too bulky to take along? With the TOWER 16 you're ready for anything . . . any time! One of the smallest made . . . smaller than a pack of cigarettes . . . yet takes 20 color slides you can show on any standard 35mm projector or make into 2 1/2 x 3 1/2 inch color prints. Black and white negatives enlarge sharply to 2 7/8 x 4 1/4 in. See pages 65 and 66 for Mamiya 16mm film, processing.

Sharp f:3.5 3-element lens, openings from f:3.5 to f:11. Seven shutter speeds from 1/2 second to 1/200 second plus time. Flash synchronized for 1/25 second. Rapid-fire shooting with action-wheel. Film advance cocks shutter. Double exposure prevention and lock. All metal. Fine Japanese construction.

3 CA 7316—Camera and leather case. Shpg. wt. 1 lb. \$29.20

Flash Unit. Attaches to camera with bracket. Metal reflector. Uses No. 5 bulbs and 2 penlight batteries (not included, see page 47).
3 CA 7317—Made in Japan. Shipping weight 1 pound. \$5.75

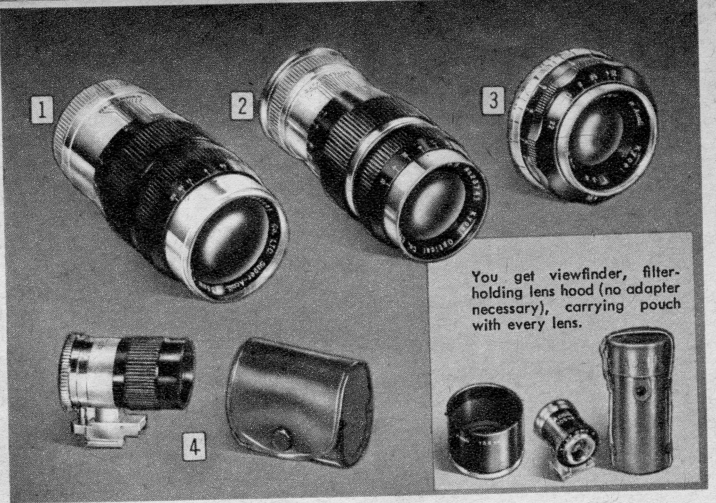

You get viewfinder, filter-holding lens hood (no adapter necessary), carrying pouch with every lens.

Telephoto and Wide-angle Lenses for TOWER 45, 46, Yashica YF, Canon and Leica Cameras (except M3)

Compare the remarkably low prices of these f:3.5 precision-made accessory lenses. All lenses stop down to f:22; all use series 6 filters (except 3CA7538, uses series 7). See page 64 for lens filters. Made in Japan.

You're never "too far away" or "too close" with accessory lenses.

Telephoto lenses—bring subjects in close for sharp, detailed pictures. 105mm for portraits, flower studies and theater productions. 135mm for wild life, birds, sporting events. **Wide-angle lens**—gives greater picture area for group shots . . . wherever you need a wider range in limited space.

- 1 135mm Telephoto Lens. Magnifies approximately three times.
3 CA 7538—Focuses 5 feet to infinity. Shipping weight 2 lbs. \$44.50
 - 2 105mm Telephoto Lens. Magnifies approximately two times.
3 CA 7539—Focuses 3 1/2 feet to infinity. Shipping weight 2 lbs. 39.50
 - 3 35mm Wide-angle Lens. Increases field of view covered by normal lens.
3 CA 7540—Shipping weight 1 lb. \$39.50
 - 4 Zoom Viewfinder. Adjusts to correct fields for any 35mm to 200mm lenses. Parallax correction. For any camera with accessory clip.
3 CA 7541—Zoom viewfinder with leather case. Shpg. wt. 8 oz. \$13.75
- Save \$3.25 on 5-piece Combination. Take advantage of this offer, separately sells for \$97.75. Consists of 135mm telephoto (1) and wide-angle lenses (3) above with individual viewfinders for both plus zoom viewfinder (4).
3 CA 7542C—5-piece Combination. Shpg. wt. 4 lbs. \$94.50

Get big pictures with a compact Folding Camera

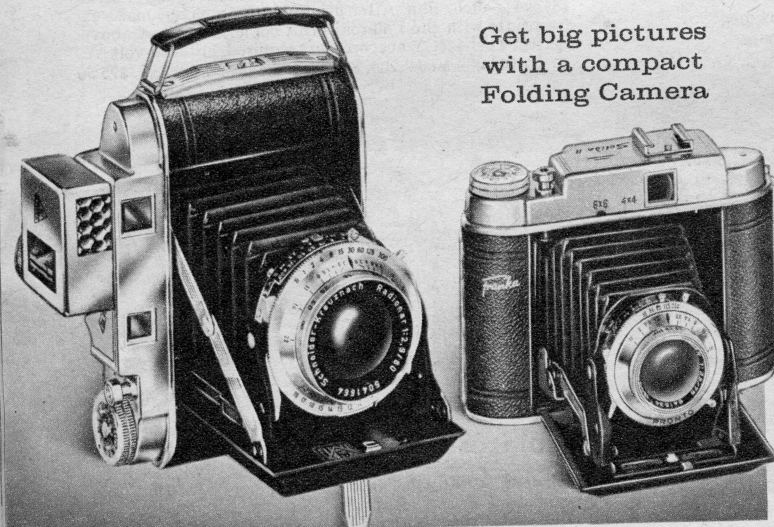

TOWER 60 . . . fast f:2.9 lens

With meter **\$4950** cash **NO MONEY DOWN**

Take the number you see on clip-on direct-reading light meter, set this number on camera . . . shoot . . . it's that easy! Special mask gives you two picture formats . . . 12 or 16 prints with 120 film.

Schneider coated lens opens from f:2.9 to f:22. Nine shutter speeds from 1 sec. to 1/300 sec., plus time. Flash synchronized (use 3CA8900 B-C Folding Flash Unit at right). Self-timer, non-coupled rangefinder. Leather-covered metal body. Takes series 6 filters. Use screw-in adapter below or 1 5/8-in. slip-on adapter, page 64. Camera made in Germany, meter in Japan.
3 CA 7360C—Camera, meter. Wt. 2 lbs. \$49.50
3 CA 7361C—Camera only. Wt. 2 lbs. 44.50
3 CA 8132—Filter Adapter. Wt. 3 oz. 2.52

Solida II . . . f:3.5 lens

\$2450 cash **NO MONEY DOWN**

Use 120 film . . . get choice of 2 picture sizes. Without mask you get 12 standard oversize (3 1/2 x 3 1/2-in.) black and white prints or 2 1/4 x 2 1/4-in. color slides. Using a special mask (incl.) you get 16 2x2-in. super slides you can show on standard 35mm projectors.

"F" stops from f:16 to f:3.5. Four shutter speeds (1/30, 1/60, 1/125, 1/250 second) plus time. Synchronized for flash. Use flash unit below. Leather covered metal body. Takes series 6 filters. Use 1 1/4-in. slip-on type filter adapter on pg. 64. Made in Germany.
3CA7322—Shpg. wt. 1 lb. 8 oz. \$24.50
3CA8900—B-C Folding Flash for above. From Japan. Wt. 8 oz. \$5.75

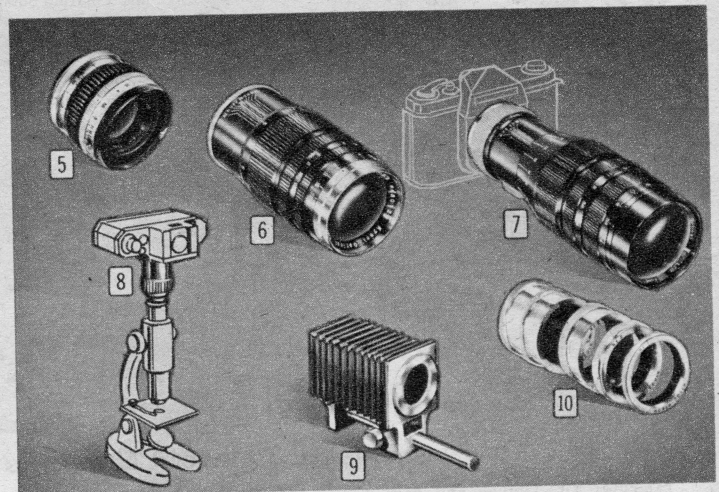

Wide-angle, Telephoto Lenses, Attachments for TOWER 26, 29, Asahi Pentax, Practica, Pentacon, Contax S & D

- 5 35mm f:3.5 Wide-angle Lens. Puts 87% more picture area on your film.
3 CA 7440—Pre-set diaphragm. Shipping weight 2 lbs. \$36.50
- 6 135mm f:3.5 Telephoto Lens. Magnifies about 3X. Focuses 6 ft. to inf.
3 CA 7439—Pre-set diaphragm. Shipping weight 2 lbs. \$44.50
- 7 250mm f:4.5 Telephoto Lens. Magnifies about 5X. Focuses 15 ft. to inf.
3 CA 7444C—Pre-set diaphragm. Shipping weight 2 lbs. \$119.50
- 8 Microscope Attachment. Adapter connects camera to any standard microscope for microphotography. Use with extension tubes (3CA7447) below.
3 CA 7445—Microscope Attachment. Shipping weight 1 lb. \$12.75
- 9 Bellows Close-up Attachment. Attaches to camera for extreme close-ups. Bellows expands for focusing to different distances.
3 CA 7446—Bellows Close-up Attachment. Shipping wt. 1 lb. \$14.75
- 10 Extension Tubes Close-up Attachment. Set of metal tubes, use between camera and regular lens to increase focal length for extreme close-ups.
3 CA 7447—Extension Tubes. Shipping weight 1 lb. \$7.75

Above lenses and attachments precision crafted in Japan

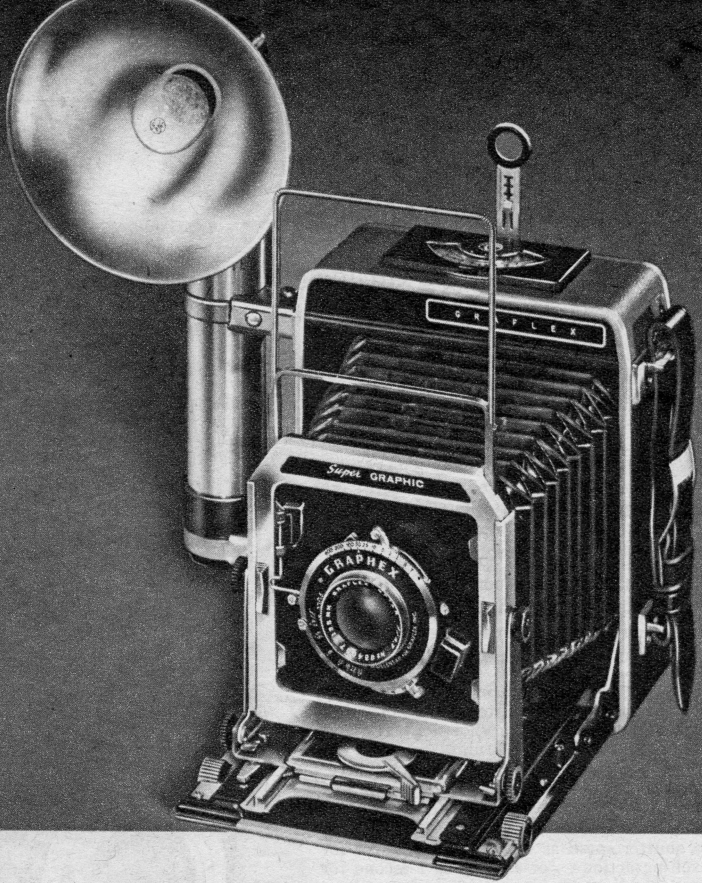
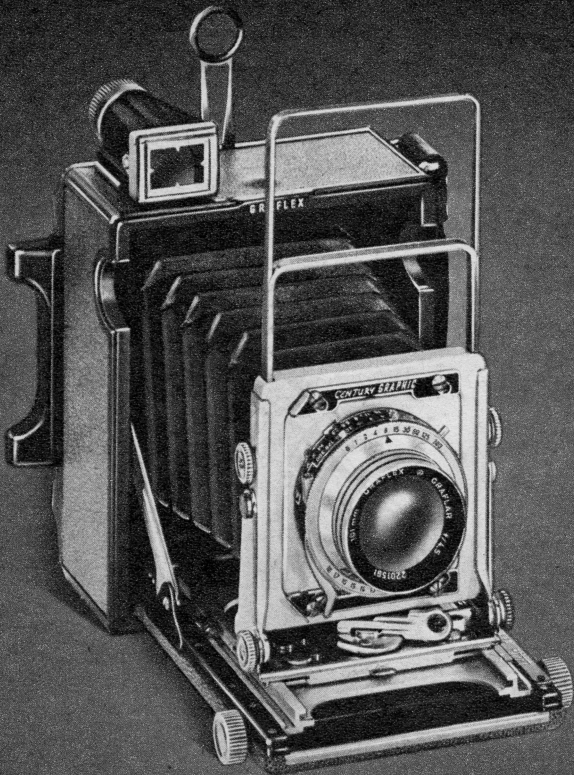

Handle any size photo job
with 2 1/4 x 3 1/4 Century Graphic

Camera only \$164.95 NO MONEY DOWN
cash

Compact Century Graphic answers all your photographic needs. Prontor SVS shutter synchronized for M-type bulbs or electronic flash at all speeds, 1 sec. to 1/300 plus bulb. Also has self-timer and EVS coupling. You can set diaphragm and shutter separately or set both with one simple EV number. 101mm f:4.5 Grafilar lens. Graflok back permits use of all Graphic accessories.

Lenses are interchangeable. Switch from normal to wide angle to telephoto in seconds. Large knobs let you focus with either hand.

Focus one of three ways: vernier scale, ground glass or with accessory rangefinder. Optical finder. You can raise, shift or tilt camera front to control distortion and perspective. When taking extreme close-ups, extend the bellows to twice its normal length.

Molded Mahogany plastic body protects camera from extreme heat, cold, humidity. Uses sheet film, roll film or film packs (see below). 2 1/4 x 3 1/4-in. negatives. Postpaid.

C3 CA 7331C—(Shpg. wt. 5 lbs.) \$8.50 month... Cash \$164.95
C3 CA 7334—Fiber Carrying Case. (Shipping wt. 3 lbs.). 22.50

Get big 4x5 pictures, use wide variety
of accessories . . . with Super Graphic 45

Cut \$24 Camera Now \$375.00 NO MONEY DOWN
cash

Automatic footage scale matches any lens, lets you calculate flash exposure. Camera has built-in 45-volt BC circuit. Synchronized for all types of flash.

Cams interchange—match lenses, operate rangefinder, focusing scale and flash calculator. Easy-to-change accessories . . . cams slip into position in a second.

Shoot from 1 second down to 1/400, plus time and bulb. Between-the-lens shutter. Release button on camera operates shutter and flash electrically.

Here are some of the advanced features you get on the Graphic Super 45—use any type of film: sheet, film pack or roll (with proper accessories). Special Presslock tripod mount (in outfit) lets you mount camera on any tripod. Flash cords plug into camera. Raise or lower the front of the camera, tilt it forward or back, adjust to right or left for greatest control of perspective and distortion. Graflex Optar 135mm f:4.7 lens.

Light and compact . . . only 7x7 1/4 x 4 inches. Aluminum body, so it weighs just 4 3/4 pounds (less flash). Also available with 1/1000 shutter.

C3 CA 7336C—Super Graphic, 1/400 shutter. Ppd. (Wt. 9 lbs.) Was \$399.00. \$18 mo... Cash \$375.00
C3 CA 7337C—Outfit. Includes camera with between-the-lens 1/400 shutter, Grafite flash with 5-in. reflector, batteries and Presslock. Postpaid. (Wt. 12 lbs.) Was \$444.20. \$19 mo... Cash \$400.00
C3 CA 7332C—Outfit as above but 1/1000 camera shutter. Postpaid. (Shipping weight 12 lbs.) Was \$494.70. \$22 month... Cash \$450.00
C3 CA 7338—Optical Finder. Ppd. (Wt. 5 oz.) 8.00
C3 CA 7339—Presslock Mount. Ppd. (Wt. 8 oz.) 9.75
C3 CA 7335—Fiber Carrying Case for Super Graphic. Postpaid. (Shipping weight 5 lbs.). \$25.00

Have the right press camera film at the right time . .
Use Adapters, Holders and Film, in 2 1/4 x 3 1/4 and 4x5 sizes

1 Polaroid Land Film Holder for 4 x 5 cameras. "Picture-in-a-minute" accessory for Polaroid film in 4 x 5-inch size. Operates by the same principle as Polaroid roll film. Fits 4 x 5 Graphic cameras with Graflok or spring-type back and most press-type view cameras having Graphic-type spring-backs.

Special film packets (below) are inserted into holder, exposed, withdrawn . . . 60 seconds after removal, picture is ready (see view at right). Use film with paper or acetate-base negative.

C3 CA 9635C—Polaroid Film Holder. Wt. 1 lb. \$48.88

Polaroid PolaPan Film Type 52 (a paper-base negative). Exposure index: daylight 200; tungsten 160. Picture size 3 1/2 x 4 1/2 inches. Use with Polaroid film holder above. Postpaid. (Shpg. wt. 8 oz.)

3 CA 9636—Box of twelve 4 x 5 film packets. . . \$6.22

Polaroid Professional Pan Film Type 53. Film has an acetate-base negative making it possible to save the negative. (Instructions included.) Exposure index and picture size as above. Use with Polaroid film holder above. Postpaid. (Shpg. wt. 8 oz.)

3 CA 9637—Box of twelve 4 x 5 film packets. . . \$7.31

2 Sheet Film Holders for press cameras. Each holds two sheets of film. Darkroom loading. Postpaid.

3 CA 7340—4 x 5 size. (Shpg. wt. 1 lb.) . . . \$4.95

3 CA 7341—2 1/4 x 3 1/4 size. (Shpg. wt. 1 lb.) . . . 4.85

3 Film Pack Adapters for press cameras. Holds 12-exposure film packs. Daylight loading. Postpaid.

C3 CA 7342—4 x 5 size. (Shpg. wt. 1 lb.) . . . \$13.95

C3 CA 7343—2 1/4 x 3 1/4 size. (Shpg. wt. 1 lb.) . . . 13.95

4 Grafmatic Sheet Film Holder . . . holds 6 sheets in a space not much thicker than that of a regular holder. Changes film rapidly . . . fast push-pull action. Automatic film counter. Fits Speed, Crown, Century Graphics with Graflok backs only. Postpd.

C3 CA 7344—For 4 x 5 cameras. (Wt. 1 lb.) . . . \$26.00

C3 CA 7345—For 2 1/4 x 3 1/4 cameras. (Wt. 1 lb.) 23.00

5 Graphic Roll Film Holders. Converts your 4 x 5 Speed and Crown Graphics with Graflok or Graflex backs to use daylight-loading black and white or color 120 roll film. Takes 8 or 12 photos per roll. Shipped postpaid. (Shipping weight 6 lbs.)

C3 CA 7346—Takes eight 2 1/4 x 3 1/4 photos. . . \$29.95

C3 CA 7347—Takes twelve 2 1/4 x 2 1/4 photos. . . 26.00

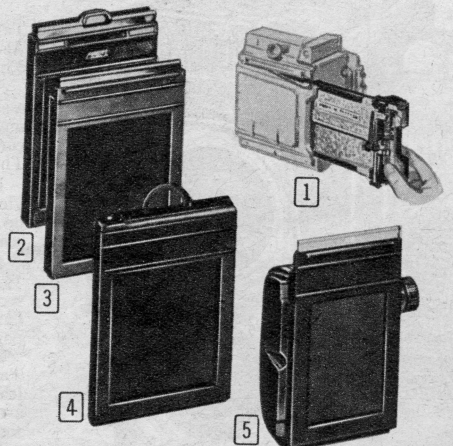

USE WHILE YOU PAY . . . see Sears Easy Terms on page 63

Take it with a Tower
Twin-Lens Reflex



Baby TOWER Twin-lens Reflex

Easy to carry, easy to focus and shoot . . .
takes 2x2-inch color super slides

\$34⁵⁰ NO MONEY
cash DOWN

- Super sharp 60mm hard-coated f:3.5 lens
- Nine shutter speeds to 1/500 sec. plus bulb
- Brilliant ground glass focusing viewfinder
- Magnifier flips up for critical focusing
- Frame fast action shots with sports viewfinder
- Get in the picture with 10-second self-timer
- Automatic frame counter, film transport
- Focuses 3.2 ft. to infinity. Depth-of-field scale
- Synchronized for bulbs and electronic flash

Get every advantage of reflex focusing and composition on a camera that's small enough to fit in your palm. Only 4¾ inches high. Take 12 snapshot-size black and white prints or color slides on 127 film.

Small size makes it easy to handle . . . easy to carry. Brilliant fine-grain ground glass viewfinder shows you exactly what tones . . . what colors to expect in your finished pictures.

Choose a shutter speed as fast as 1/500 second for stopping exciting action . . . or as slow as 1 second for creative available light pictures indoors. Lens openings from f:3.5 to f:16 permit you to shoot under widely varying light conditions.

Load it today, take pictures next week "memory" dial reminds you what type of film you loaded. Camera precision made in Japan for Sears. Rugged, all-metal body. Takes series 5 filters. Use bayonet-type filter adapter below. Use B-C flash unit (3 CA 8900) below or any electronic flash unit on page 51.

3 CA 7704—Camera only. Shpg. wt. 3 lbs. \$34.50
3 CA 7705—Leather Case for above. Wt. 8 oz. 4.75
3 CA 8022—Filter Adapter for above. Wt. 3 oz. 2.19



You see picture-size view

Taking pictures the reflex way is almost like having your finished picture in your hand . . . and being able to change it at will! When the view on the screen is sharp, you're in perfect focus.

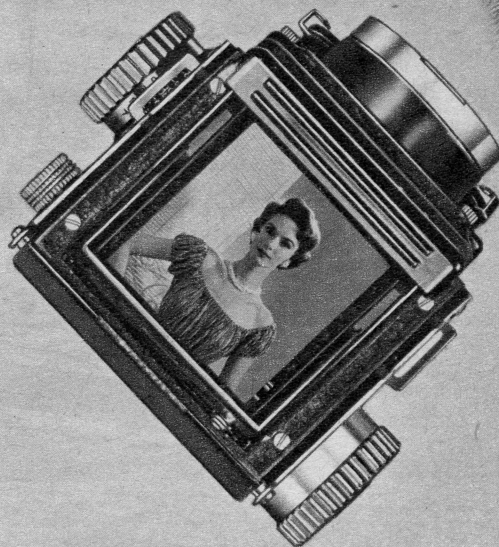

Square format plus large negative equals endless composition possibilities and bigger, sharper enlargements. It's easy to handle a reflex. You can shoot at waist level, eye-level, on ground, or even over crowds, like a periscope!

Yashica 44LM Twin-lens Reflex with built-in photoelectric exposure meter

Camera with case **\$59⁹⁵** NO MONEY
cash DOWN

- No guessing . . . meter tells you what settings to make . . . gets you the best picture possible
- Hard-coated, color-corrected 60mm f:3.5 lenses
- Ten shutter speeds to 1/500 second plus bulb
- Brilliant focusing screen with magnifier

Take 12 black and white or color pictures on 127 film. Also take super slides you can show on any standard 35mm slide projector.

Shoot with confidence, right from the start. Just read a single number indicated on meter . . . dial same number on side of camera and read your lens opening number and correct shutter speed from a window next to meter. Then set, focus and shoot.

Focus quickly and compose accurately with brilliant viewfinder. Bright spot in center of screen lets you focus on subject detail. Red lines help you line up subject when composing. Shoot pictures as close as 3 feet away.

Lens openings from f:3.5 to f:22. Shutter speeds (1, 1/2, 1/4, 1/8, 1/15, 1/30, 1/60, 1/125, 1/250 and 1/500 second) plus bulb. Synchronized for bulbs and electronic flash. Use B-C flash unit below or any electronic unit on page 51. Other features include sports finder, film speed setting, depth-of-field scale. Die-cast aluminum body. Takes series 5 filters with adapter below. Top grain leather case with strap included.

3 CA 7759C—Camera, case. Made in Japan. Wt. 3 lbs. \$59.95
3 CA 8900—Flash Unit, case. Made in Japan. Wt. 8 oz. 5.75
3 CA 8022—Bayonet-type Filter Adapter. Wt. 3 oz. 2.19

See handy photo index on page 3

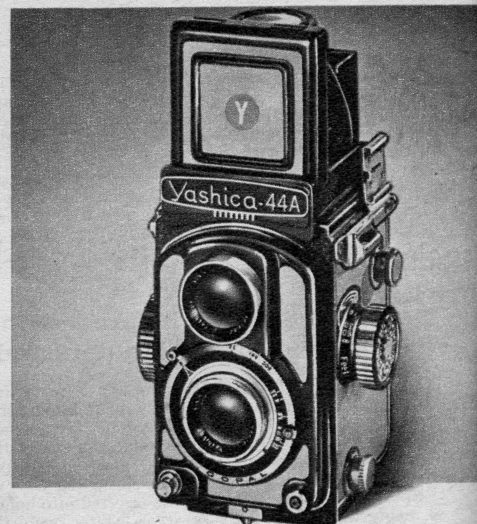

Baby Yashica 44A

Camera with case **\$29⁹⁵** NO MONEY
cash DOWN

Focuses 3½ ft. to infinity. Lens openings from f:3.5 to f:22. Four shutter speeds (1/25, 1/50, 1/100, 1/300) plus bulb. Synchronized for flash (use B-C flash unit (3CA8900) at left).

Knob wind, Leather-covered metal body. Takes 12 pictures on 127 film. Takes series 5 filters with adapter below. Made in Japan.

3 CA 7716—Camera with case. Wt. 2 lbs. . . . \$29.95
3 CA 8036—Filter Adapter. Wt. 4 oz. 2.19

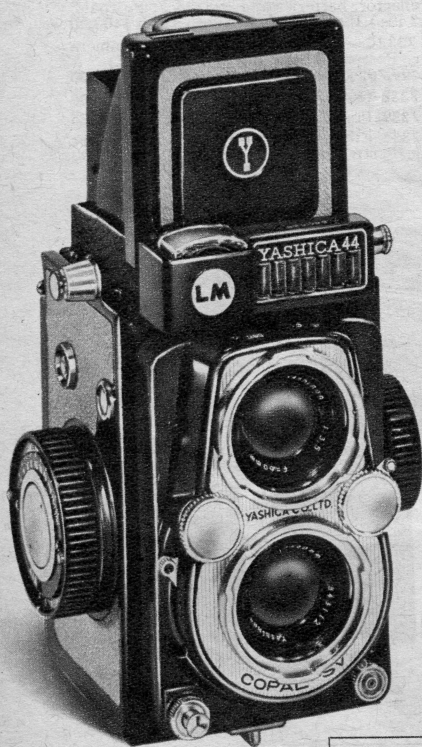

NO MONEY DOWN on Sears Easy Terms . . . see page 63 for details



at the same time you compose and focus

Low-priced TOWER 2 1/4 x 2 1/4 Reflex with hard-coated f:3.5 lens

\$24.50 cash NO MONEY DOWN

- Four shutter speeds . . . synchronized for flash
- Big ground-glass viewfinder for picture-size viewing
- Sports-type viewfinder for quick action shots

1 High-speed 75mm coated lens focuses from 3 1/4 ft. to infinity. Built-in magnifier. Lens openings f:3.5 to f:22. Shutter speeds 1/25, 1/50, 1/100, 1/300 second plus bulb. Takes 12 pictures or 2 1/4 x 2 1/4 color slides on 120 film. Metal body, leatherette covering. Takes series 5 filters without adapter.

3 CA 7718—Camera only. Made in Japan. Shpg. wt. 3 lbs. \$24.50

3 CA 8900—Tower B-C Flash for above. Batteries, case included. Uses M2 or No. 5 bulbs. Made in Japan. Shpg. wt. 8 oz. . . . \$5.75

3 CA 7719—Leather Case for camera above. Wt. 12 oz. . . . 4.75

3 CA 7706—3-piece Outfit. Includes camera, leather case, Tower flash unit. Shpg. wt. 3 lbs. 8 oz. . . . \$34.75

Our Best 2 1/4 x 2 1/4 Reflex has match-the-needle exposure system

Get correct exposure every time with built-in meter! Simply match up two needles . . . set lens, focus and shoot

2 Coated 75mm f:3.5 lens focuses from 3 1/4 ft. to infinity. Nine shutter speeds from 1 to 1/3000 second plus bulb . . . synchronized for bulb and flash. Lens openings f:3.5 to f:22. Shutter speeds 1/25, 1/50, 1/100, 1/300 second plus bulb. Takes 12 pictures or 2 1/4 x 2 1/4 color slides on 120 film. Metal body, leatherette covering. Takes series 5 filters. Use adapter below. . . . \$24.50

SORRY—NOT AVAILABLE

—Camera only. Shpg. wt. 2 lbs. 6 oz. . . . \$24.50

—Leather Case for above. Shpg. wt. 12 oz. . . . 4.75

—Filter Adapter for above. Shpg. wt. 3 oz. . . . 2.19

—3-piece Outfit. Camera, case, flash. Wt. 4 lbs. . . . \$34.75

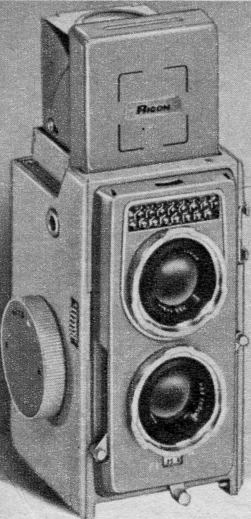
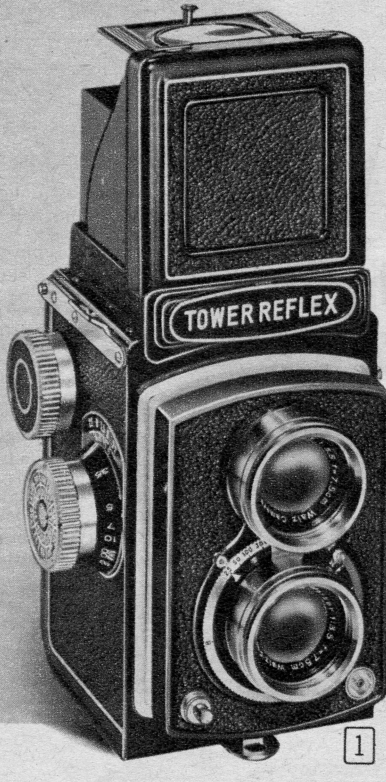
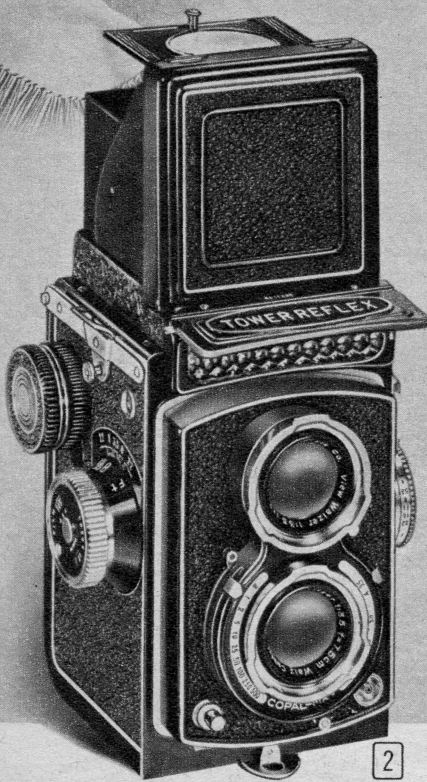

Ricohmatic 44

Take pictures faster with built-in meter

In a window over the exposure meter, you'll see a needle and a dot. Just turn a dial to match them up . . . then focus and shoot! No separate shutter settings to make.

Exclusive "duo-lever" focusing. You focus faster with either hand by sliding levers located on both sides of camera.

Camera with flash \$49.50 cash NO MONEY DOWN

Get the benefits of ground-glass, reflex viewing without the job of figuring exposures. Shoot still scenes or action shots easily with brilliant viewing screen . . . flip up magnifier and exclusive sports finder that lets you use both eyes. Ricoh 60mm f:3.5 taking and viewing lenses. Removable plastic front-cover protects lenses . . . flips open when focusing hood is raised. Completely self-contained. No extra case to buy.

Take 12 black and white or color prints . . . super slides too, on 127 film. Accessory shoe has built-in flash contact. Cordless flash unit included. All-metal body is lightweight, easy-to-handle. Attractive gray finish. Large diameter, film-advance knob. Light meter adjustable to match speed of film you're using. Takes series 5 filters. Use bayonet-type filter adapter below. Shpg. wt. 2 lbs.

3 CA 7717C—Camera with flash unit. Made in Japan. . . . \$49.50

3 CA 8022—Filter Adapter for above. Shpg. wt. 3 oz. . . . 2.19

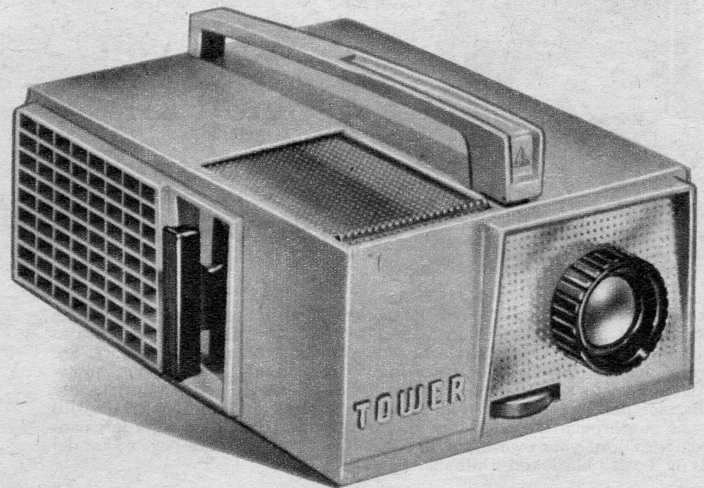

TOWER 2 1/4 x 2 1/4 Slide Projector also shows stereo, 35mm and super slides with adapters

\$36.00 cash NO MONEY DOWN

Get sparkling projection from 300-watt proximity mirror-lamp. Sharp 5-inch f:3.5 lens. No visual slide movement. Manual changer blacks out screen between pictures. Blower cooled. Convenient tilting device. Storage space for 40 slides.

Die-cast aluminum body with handle. Smart-looking 3-tone gray, blue and black. UL listed. 110-120-volt, 60-cycle AC only.

3 CA 9830—Projector. Shpg. wt. 9 lbs. . . . \$36.00

35mm and Super Slide Adapter plus conversion lens.

3 CA 9831—Shpg. wt. 10 oz. . . . \$4.50

Stereo Slide Adapter. Shows half of a stereo slide. Includes auxiliary lens.

3 CA 9832—Shpg. wt. 8 oz. . . . \$4.79

Extra 300-watt Projection Lamp (CRA).

3 CA 8687—Shpg. wt. 4 oz. . . . \$3.87

Even our lowest-priced Tower 35's give you

TOWER 55 with f:3.5 coated lens...easy and simple to use...ideal for beginners in 35mm photography

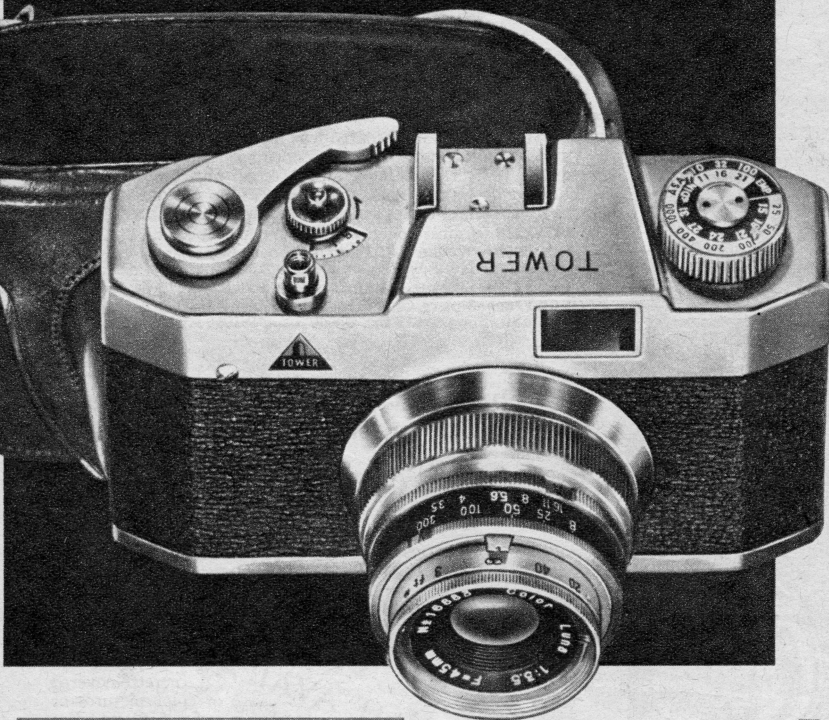

Amazing low price for this quality

Camera only \$ **15⁵⁰**

Look at all it does:

Even takes low light pictures. Just open lens wider—openings from f:3.5 to f:16. Synchronized for flash, too.

Stops fast action. Gives you 4 shutter speeds: 1/25, 1/50, 1/100 and 1/300 second, plus "bulb" time setting.

Won't double-expose. Rapid-wind lever advances film before cocking shutter. Counts pictures taken, too.

Correct film exposure. ASA film speed reminder dial lets you know speed of film in camera at all times.

Look through optical viewfinder, press the button... *you've got it!* Simple to work as a box camera. But once you get used to all its features you wouldn't be without them. Saves the day when the sun is in, making beautiful pictures a matter of course, not chance.

Lens adjusts from 3 feet to infinity. A little red signal tells you when shutter is cocked. Sturdy all-metal body with handsome leather covering. Takes series 5 filters. Use screw-in type filter adapter listed below. Expertly made in Japan.

3 CA 7414—Camera only. Shipping weight 1 pound 8 ounces...\$15.50

3 CA 7416—Leather Eveready Case. Shipping weight 1 pound... 3.25

3 CA 7420—3-piece outfit. Includes TOWER 55, Leather Eveready Case and Folding B-C Flash Unit. Shpg. wt. 3 lbs.....\$23.50

3 CA 8182—Screw-in Type Filter Adapter. Shpg. wt. 3 oz..... 2.19



What you should know about 35mm photography

Take slides or snapshots. Darken the room... flood the screen with big lifelike scenes in full, breathtaking color. No wonder color slides are so popular with so many people. Above is an actual size slide as it comes from the laboratory. See page 66 for fine TOWER color processing. Kodachrome, Ektachrome, Anscochrome and TOWER Color are familiar types of films. For color prints, use Kodacolor film or reproduce from slides. Take black and white pictures with TOWER panchromatic, Kodak Plus-X, Ansco Super Hypan and Agfa fast panchromatic. Print your own if you like from developed film. See page 65 for details on TOWER black and white photo service.



Carry camera with ease. Light and compact... some so small you can take many pictures without your subject knowing it. Some fit in your palm, and won't weigh you down during an all-day excursion. Stays with you and ready to catch that "never again" picture. An eveready case keeps camera comfortably at your side... protects it, too, from possible damage. Damage seldom happens, however, for these compact cameras are ruggedly built.

Take sharp, clear pictures with ease. 35mm lenses have great depth of field (sharp focus) and rarely require critical focusing. Widest lens openings are usually f:3.5 or better, giving them great light-transmitting ability. This enables shooting pictures in dim light. You can take fine pictures with a 35mm camera and instructions for getting them, come with your film.

Take prize pictures—all kinds of pictures. You're a versatile photographer with a 35mm camera. Try taking informal portraits by window light only, using fast film. Shoot by candlelight too—easier with a fast lens and a slow shutter speed setting as on TOWER 57A. Stop children in the middle of vigorous play with a shutter speed of 1/100 second or faster. Count on a rangefinder to help make the finished picture sharp—no guesswork about distances... none about correct exposure, either, with a built-in light meter.

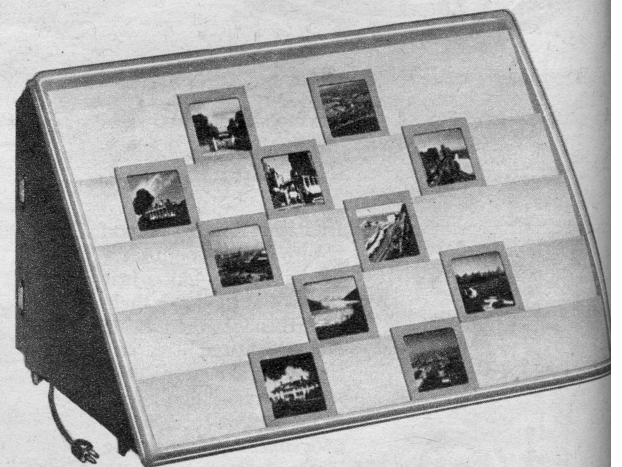

Edit slide shows that "tell a story"
... New TOWER Slide Sorter

Holds 35 2x2 slides \$ **3⁹⁵**

Ever fumble in the dark arranging your slides? Here's a new and better way to edit a show that flows smoothly. Just stand slides on white plastic "stairs" and arrange them in a flash. You see them all at once. Lights every slide evenly, brilliantly. Make critical comparisons, check relative exposures.

Holds nearly a whole camera load. Sturdy fiberboard sides and back. On-off switch. Use 25 or 40-watt household bulb (not included). 110-120-v., 60-c. AC-DC. UL listed cord and socket. 3 CA 9901—Measures 14x10x8 inches. Shpg. wt. 2 lbs..... \$3.95

Build your order to \$20 or more
... use Sears Easy Terms

sharp color slides, prints

TOWER 57A...an easy-to-use advanced camera
You just read meter...set lens and shutter...aim and shoot



TAKE IT WITH A
TOWER 35mm



Be sure when you shoot! TOWER 57A with f:2.8 lens cuts guesswork...has light meter and coupled rangefinder

Camera only \$ **34.44** NO MONEY DOWN
cash

See your picture. Bright lines in viewfinder outline the shot. Lower top lines outline close-ups—prevent cropping off part of subject. Center diamond shows double image until focus is perfect.

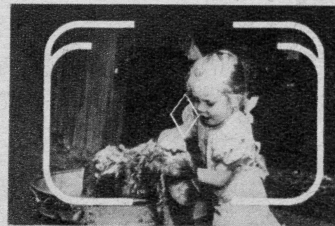

▶ Light meter. Just align 2 needles...choose from whole set of correct pairs of "f" stops and shutter speeds. For film speeds 10 to 800.

No other 35mm camera we know of offers all these refinements at such low cost. Not only does it save you hit-or-miss figuring of light and distance...this camera does much more.

Takes pictures in dimmer light than cameras with slow lenses. That's especially important with color film—not as sensitive as black and white. Has a fast lens with openings from f:2.8 to f:22. Equipped to take action shots too...as readily as dramatic still lifes. Offers 8 shutter speeds: 1, 1/2, 1/5, 1/10, 1/25, 1/50, 1/100, 1/300 second. Focuses on subject from 3 feet to infinity with just 1/2 turn of the focusing knob. Depth of field scale tells range of sharp focus.

No winding after each shot...just one stroke on the rapid film lever smoothly advances film, counts pictures taken, cocks shutter and prevents double exposures—four jobs at once. Hinged back makes for quick, easy loading and unloading. "Memory" film speed dial and rewind knob.

Rugged metal body with leather cover. Camera expertly crafted in Japan to Sears rigid specifications. Synchronized for flash bulbs and for electronic flash. See flash units on pages 50 and 51. Takes series 6 filters. See filters on page 64. Use screw-in type filter adapter listed below.

3 CA 7424—Camera only. Shipping weight 3 pounds...\$34.44

3 CA 7425—Camera with leather case. Shpg. wt. 4 lbs... 39.44

3 CA 8184—Screw-in Type Filter Adapter. Shpg. wt. 3 oz... 2.52

USE SEARS EASY TERMS for your camera purchases. See page 63

Featherweight Electronic Flash fits in your pocket!

New! Ultrablitz MonoJet SP—no bulky power pack to tote...only 16 ounces

\$ **59.95** NO MONEY DOWN
cash

Smallest made...and you get power and speed to spare. Freeze action with startling 1/1300 second flash duration. No shutter setting problems, just set lens opening according to built-in flash calculator. Ultra-convenient size...only 4 3/4 x 3 1/4 x 1 1/2 inches. Nickel-cadmium battery lasts indefinitely, recharges to full power in only 3 hours. Each charge gives 60 full-power flashes. Shoot...shoot again in just 10 seconds. Square reflector throws uniform 60° beam...no annoying "hot spots." Charges on ordinary household 110-120-volt AC current...operates on AC current too.

Built-in charger, voltage-regulating monitor circuit. Regular Kodachrome Guide No. 32. Includes shutter cord, charging cord and mounting bracket. Why keep buying flash bulbs...go electronic!

3 CA 8918C—From W. Germany. Wt. 3 lbs...\$5 monthly. Cash \$59.95

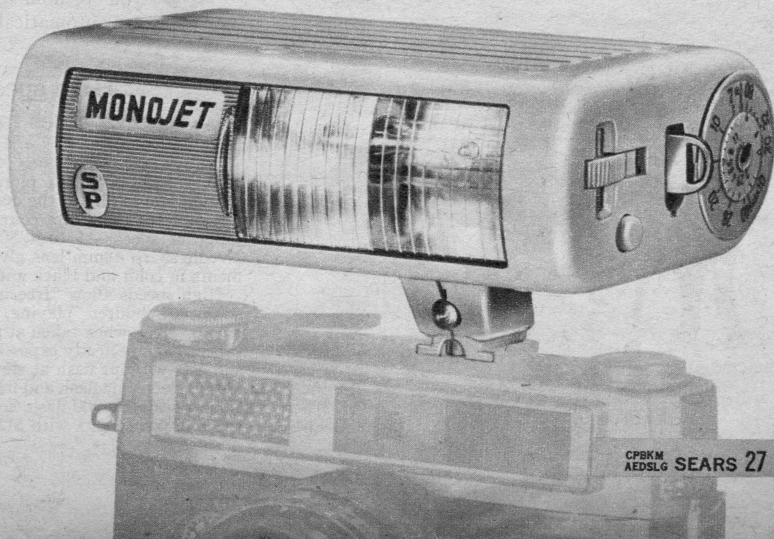

CPBKM
AEDSLG SEARS 27

TOWER 19: a twist locks in new lens!
Lenses bayonet-mounted for rapid interchange.
Rangefinder and handy exposure meter built in.

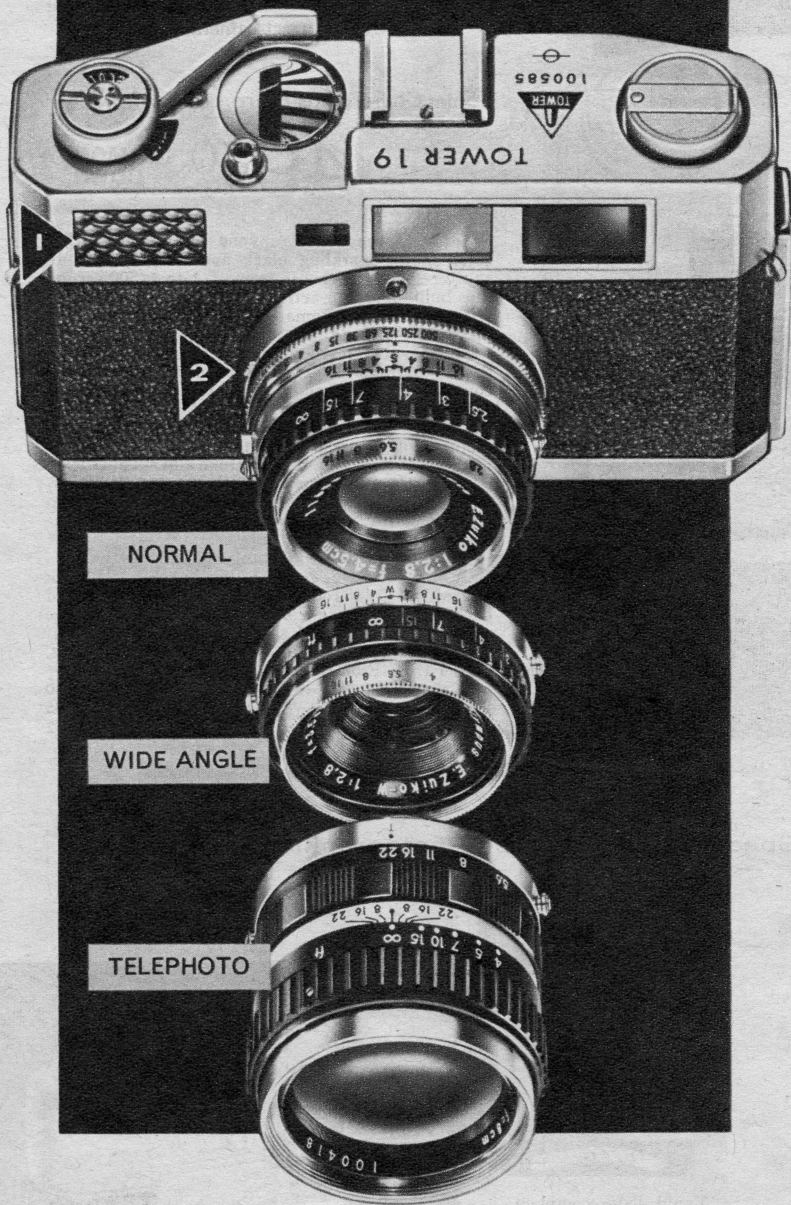

More exciting photos..

Bring distant scenes right up close . .

TAKE IT WITH A
TOWER 35mm



Higher priced camera features

Camera with normal lens **\$78⁹⁵** NO MONEY DOWN
cash

1 Tells lens setting instantly. No guessing. Set camera for any shutter speed. Exposure meter automatically points to the correct "f" stop. All you do is set the lens. Change to a new shutter speed and your new "f" stop appears in exposure meter—instantly, correctly.

2 Works for all 3 lenses. Focus until rangefinder shows single image. Then look in viewfinder—three bright gold-color frames, one inside the other, for normal, wide angle and telephoto shots. All automatically compensate for parallax and keep subject centered.

A versatile camera with or without the accessory lenses (sold below). With them, twice the camera! Each is a complete lens in itself—almost unheard of at this low price. Switch lenses and you're not just adding more glass. You're adding an entirely new optical system. You get true wide angle, telephoto and normal results!

All lenses are quick-change artists. Bayonet-mounted wide angle and telephoto lenses automatically couple to camera rangefinder. Takes seconds—and saves seconds—when seconds may save the shot.

Camera itself takes sparkling pictures under a wide range of conditions. Normal 45mm lens opens up to f:2.8 when you've little available light. Focuses from 2½ feet to infinity. You've 10 shutter speeds to pick from, going from 1 second to 1/500 second—fast enough to use today's super-fast films in full sunlight, slow enough to take creative low-light shots. Bulb setting and self-timer.

Synchronized for flash (see 3 CA 8900, page 51). Single-stroke film advance. Convenient depth of field scale. Camera, lenses precision-built in Japan to Sears specifications. All-metal body with leather cover. Uses series 6 filters (see page 64) and screw-in type filter adapter below.

- 3 CA 7400C—Camera. Shipping weight 3 pounds. \$78.95
- 3 CA 7401—Leather Case. Shipping weight 8 ounces. 6.75
- 35mm Wide Angle f:2.8 Lens. Uses series 6 filters.
- 3 CA 7403—Shipping weight 1 pound. 39.50
- Screw-in Type Filter Adapter for above normal and wide angle lenses.
- 3 CA 8147—Shipping weight 3 ounces. \$2.52
- 80mm Telephoto f:5.6 Lens. Uses series 6 filters.
- 3 CA 7402—Shipping weight 1 pound. 39.50
- Screw-in Type Filter Adapter for above telephoto lens.
- 3 CA 8187—Shipping weight 3 ounces. 2.52

35mm Match-matic Argus C3 with meter

4-piece Outfit **\$49³⁹** NO MONEY DOWN
.. now only cash

Just match numbers and shoot! No conventional shutter speed and "f" stop markings. Just numbers. Get correct pair of numbers for shot from clip-on exposure meter. Easy . . . accurate! Sharp 50mm f:3.5 Cintar lens (interchangeable lenses sold separately below). Coupled rangefinder. Automatic exposure counter. Plastic and metal body. Synchronized for flash. Uses series 5 filters, no adapters needed.

- 3 CA 7477C—Camera, meter, flash unit, leather case. Wt. 5 lbs. \$49.39
- 3 CA 7522—Standard Argus C3 Camera only. Shpg. wt. 3 lbs. . . . 26.33
- 3 CA 7523—Leather Case for Standard C3 above. Shpg. wt. 8 oz. 7.50
- 135mm f:4.5 Telephoto Lens (also fits regular Argus C3 with accessory clip). Magnifies 2½ times, focuses down to 8 ft. Couples to rangefinder. Handy click stops, viewfinder mask, built-in sunshade.
- 3 CA 7536—From Japan. Shipping weight 1 lb. \$34.95
- 3 CA 7537—Optical Viewfinder for above. Case. From Japan. Wt. 3 oz. 6.35
- 3 CA 7535—35mm f:3.5 Wide Angle Lens. Increases field of scene 87%. Focuses to 3 ft. Matching optical viewfinder, built-in sunshade. Uses series 5 filters, no adapter needed. From Japan. Shpg. wt. 8 oz. . . . \$34.95

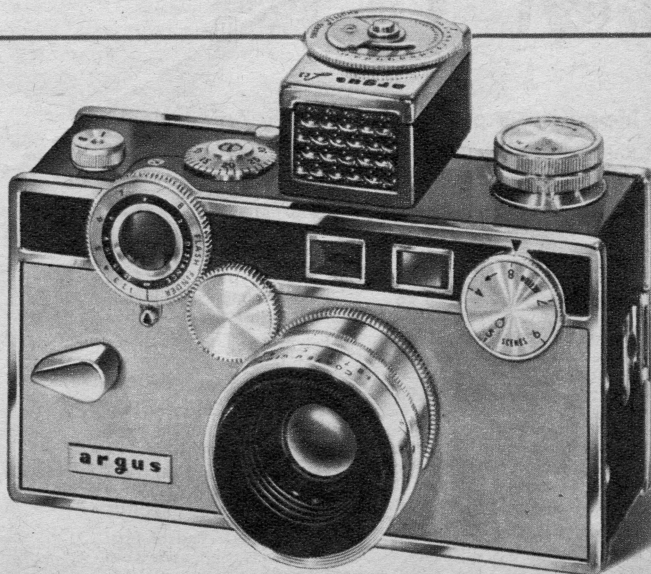

"shooting" fun with interchangeable lens cameras

take entire scenes . . . wider than you may have thought possible



35mm Nikon SP . . .
built-in viewing for 6 lenses

With f:1.4 lens **\$375.00** NO MONEY DOWN
cash

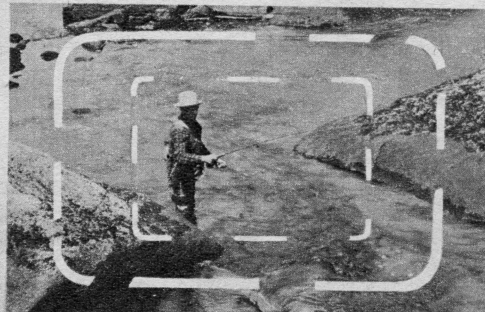

View your exact picture area for wide angle through telephoto lenses without time wasting changing of finders. A quick dial turn adjusts finder for telephoto shots . . . simply shift eye for wide angle shots.

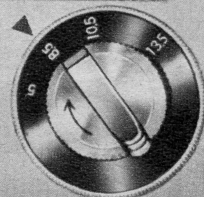

Nikon SP and S3 cameras sold with high-speed 50mm Nikkor f:1.4 lens . . . gives excellent results in dim light without flash, or fast 50mm f:2 lens. Both give clear, sparkling results in color and black and white.

Nikon S3 (sold below) is similar in every detail to SP except has trifocal viewfinder. You'll see the exact area covered by 35mm, 50mm and 105mm lenses . . . parallax markings are built in for these focal lengths.

Many Nikon accessories available as rapid-fire electric motor drive (takes 3 shots per second), 20 accessory lenses to 1,000mm, copying outfits. Write Sears Personal Service Dept. for equipment and prices not listed.

Imagine, you'll actually choose the lens to suit your subject or scene by previewing pictures you'll take with lenses to 135mm. Reach out and bring distance scenes right up close . . . almost 3 times closer with telephoto lens. Wide angle lens gets more into your picture, whether you're shooting family groups or capturing the scenic beauty of the outdoors. (Extra lenses sold at right.) Won't accidentally crop pictures . . . finder automatically corrects parallax for normal and telephoto lenses. Parallax markings for 35mm lens.

Focal plane shutter has speeds 1 to 1/1,000 sec. plus time, bulb . . . extra-fast operating for increased shutter accuracy. Removable back for quick loading, easy cleaning. Single-stroke film advance lever also cocks shutter, counts exposures. Automatic frame counter. Synchronized for flash bulbs, speedlight. Self timer. Takes series 6 filters. Metal body, leather trim. From Japan.

- F3 CA 7488—Nikon SP with 50mm coated f:1.4 Nikkor lens. (Shpg. wt. 4 lbs.) \$375.00
- F3 CA 7489—Nikon SP with 50mm coated f:2 Nikkor lens. (Shpg. wt. 4 lbs.) 329.50
- F3 CA 7490—Nikon S3 with 50mm coated f:1.4 Nikkor lens. (Shpg. wt. 4 lbs.) 315.00
- F3 CA 7491—Nikon S3 with 50mm coated f:2 Nikkor lens. (Shpg. wt. 4 lbs.) 269.50
- F3 CA 7492—Clip-on Shutter-coupled Exposure Meter and Case. (Wt. 6 oz.) 25.50
- F3 CA 7493—Leather Case for cameras with meter attached. (Shpg. wt. 1 lb.) 20.00
- 3 CA 8187—Screw-in Filter Adapter for 50mm f:1.4 Nikkor. Shpg. wt. 3 oz. 2.52
- 3 CA 8132—Screw-in Filter Adapter for 50mm f:2 Nikkor. Shpg. wt. 3 oz. 2.52
- F3 CA 7494—135mm Nikkor f:3.5 Telephoto Lens, bayonet mount. (Wt. 2 lbs.) 135.00
- F3 CA 7495—35mm Nikkor f:3.5 Wide Angle Lens, bayonet mount. (Wt. 1 lb.) 89.50
- F3 CA 7496—Clip-on BC-type Flash Attachment. Slips directly onto camera . . . needs no connecting cords. Fan-fold reflector, tilting head. (Shpg. wt. 2 lbs.) 18.75

SHIPPING NOTE: Numbers beginning with "F" shipped postpaid from factory warehouse in New York City. 3CA8187, 3CA8132, 3CA8114 sent from mail order house. Customer pays postage.

NO MONEY DOWN on Sears Easy Terms . . . see page 63



35mm Nikon F . . . through the lens viewing

With f:1.4 lens **\$375.00** NO MONEY DOWN

Smoothness, speed and hushed precision. World-famous Nikkor lens. You get exactly what you see . . . brilliant and sharp. Depth-of-field preview . . . press button and lens stops down to "taking" aperture; opens wide when you release finger.

F . . . lens closes to pre-selected aperture, mirror flips up, focal plane shutter (1 to 1/1000 sec.) opens and closes. Instantly mirror returns to viewing position, diaphragm opens.

Single stroke advance cocks shutter, counts exposures. Synchronized for flash bulbs, speedlight. Self-timer, removable back. Series 7 filters. Many accessories available (see where to write in description of SP above). Metal body, leather trim. From Japan.

- F3 CA 7580—Nikon F with 50mm f:1.4 lens. (Wt. 4 lbs.) 375.00
- F3 CA 7579—Nikon F with 50mm f:2 lens. (Wt. 4 lbs.) 329.50
- F3 CA 7584—Dual-coupled Exposure Meter, case. (Wt. 6 oz.) 36.50
- F3 CA 7581—Brown Leather Camera Case. (Shpg. wt. 1 lb.) 16.50
- 3 CA 8114—Screw-in Filter Adapter. Shpg. wt. 3 oz. 4.89
- F3 CA 7582—35mm f:2.8 Wide Angle Lens. Wt. 1 lb. 145.00
- F3 CA 7583—135mm f:3.5 Telephoto Lens. Wt. 2 lbs. 155.00
- F3 CA 7585—BC-5 type Flash with coupler. Wt. 2 lbs. 22.50

See your picture as it will look..

TOWER 37: you compose without guesswork . . . see exactly what the lens sees . . . get exactly what you see

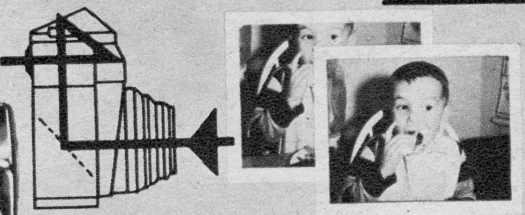

TAKE IT WITH A
TOWER 35mm

See your full picture brilliantly, sharply through the pentaprism viewfinder. Cocking diaphragm keeps lens wide open to focus . . . stops down to preset "f" stop automatically.

Never again can the problem of parallax cause you to lose part of your picture. Get as much or as little in your picture as you like. The TOWER reflex shows it all . . . even when you change lenses. Extra viewfinders for lenses are unnecessary.

Automatic diaphragm gives maximum viewing brightness \$ **88⁹⁵** cash **NO MONEY DOWN**

Combines the sureness of single-lens reflex composing with true lens interchangeability in a single camera. Bring distant subjects nearly three times closer with 135mm f:2.8 telephoto lens. Sweeping scenic shots outdoors, large family groups indoors, the 35mm f:2.8 wide angle lens gets it all.

Extra lenses (sold at right) have automatic diaphragm . . . bayonet mounts for quick, positive changing. Single-stroke rapid advance lever moves film to next frame, cocks shutter and prevents double exposure.

Get sharp, sparkling photos in color and black and white with fast, 48mm f:2.8 lens. Take beautiful pictures close as 1.75 feet with ground glass focusing. Precision focal plane shutter has speeds 1 to 1/500 second plus bulb. Synchronized for flash, (takes 3CA8900 flash, see page 51) and electronic flash. Take exciting close-ups inches away.

Extension rings and flexible bellows attachment let you shoot objects actual size (for copying, etc.) and larger. With microscope attachment on your microscope; you can actually photograph subjects invisible to the eye. Close-up attachments sold below.

Built-in film reminder scale, smooth rapid film rewind lever. Automatic film counter. Depth of field scale. All metal body, leather trim. Uses series 7 filters. From Japan.

- 3CA7434C-Camera. Shpg. wt. 3 lbs. . . . \$88.95
- 3CA7435-Leather Camera Case. Wt. 1 lb. 7.75
- 1 3CA7437C-Telephoto Lens. Wt. 2 lbs. 73.95
- 2 3CA7436C-Wide Angle Lens. Wt. 1 lb. 59.50
- 3CA8114-Filter Adapter. Shpg. wt. 3 oz. . . 4.89
- 3 3CA7430-Bellows Attachment. Shipping weight 1 lb. . . . \$14.50
- 4 3CA7432-Extension Rings. Wt. 1 lb. . . 8.65
- 5 3CA7431-Microscope Attachment. Shipping weight 1 lb. . . . \$11.95



35mm Nikkorex . . follow-pointer light meter

\$ **130⁰⁰** cash **NO MONEY DOWN**

Nikkor optical system plus coupling of lens, shutter and meter for accurate shooting. Indicators in viewfinder, meter window show correct exposure. Bright, clear focusing . . . automatic diaphragm opens lens to focus, stops down when shutter released. One stroke advances film, cocks shutter and opens lens.

Synchronized for bulbs and electronic flash. Uses 3C8900 flash on page 51. Shutter speeds 1 to 1/500 second plus bulb and self timer. 50mm f:2.5 Nikkor lens focuses to 2 feet. Swift film rewind with fold-away rewind handle. Exposure counter automatically resets after every roll.

Brilliant focusing in viewfinder has built-in split image rangefinder. Takes 90mm f:5.6 telephoto and 35mm f:5.6 wide angle attachment-type conversion lenses . . . without parallax.

Lenses (sold below) include cases. Uses series 6 filters (see page 64). All metal body, leather trim. From Japan. Camera and auxiliary lenses are sent postpaid.

- C3CA7452C-Nikkorex Camera with case. Nikkor f:2.5 lens. Postpaid. (Shpg. wt. 4 lbs.) . . . \$130.00
- 3CA8132-Filter Adapter. Shpg. wt. 3 oz. . . 2.52
- C3CA7453C-Telephoto Lens. Ppd. (Wt. 1 lb.) 49.00
- C3CA7454-Wide Angle Lens. Ppd. (Wt. 8 oz.) 44.00



through the lens..with a single-lens reflex

TOWER 32A: 35mm Reflex

Ends all guessing for composing..focusing..exposure
See your exact picture through the lens..line up meter
needles..get sharp, perfectly exposed pictures

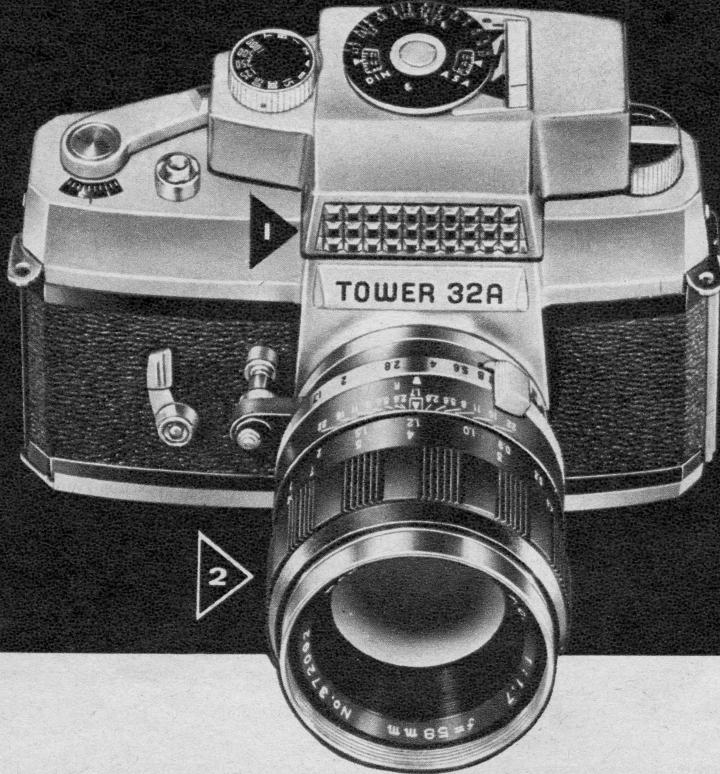

Get super-speed 58mm f:1.7 lens . . fastest
lens ever on a TOWER single-lens reflex

\$143⁹⁵ cash **NO MONEY DOWN**

1 Direct-reading exposure meter. Not a calculation for you to make . . read number meter needles point to . . set lens to same number . . get exposure-perfect slides, prints. Sensitive exposure meter has 2 operating scales . . makes readings easy to get even in dim light. Sold separately below.

2 Focus through high-speed lens . . get sharper pictures and spend less time in adjusting. Extra-large lens opening lets more light come through . . you see a brighter, clearer image in viewfinder. Even indoors in dim light you get positive precise focusing.

Precision crafted single-lens reflex has a host of features that assure needle sharp, perfectly composed slides and prints. Subject stays in view even after you shoot with instant return mirror. Hard coated 58mm lens focuses to 1¼ feet. Focal plane shutter has full range of speeds . . 1 second to action "freezing" 1/1000 second.

Extra-bright viewfinder . . automatic diaphragm lets you focus through lens at its widest opening . . stops down to preselected opening when you shoot. Fully flash synchronized . . takes 3 CA 8900 flash page 51, and electronic flash. Takes same accessories as

Tower 37 sold on facing page, including telephoto and wide angle lenses for dramatic effects. Built-in self timer lets you get into picture. Takes series 7 filters. Single stroke film advance also cocks shutter, counts exposures, prevents double exposures. Built-in film reminder scale. Smooth working film rewind lever. Depth of field scale. Metal body, leather trim. From Japan.

3 CA 7632C—Camera. Shpg. wt. 4 lbs. \$143.95
3 CA 7638—Leather Case. Shpg. wt. 1 lb. 8.50
3 CA 7639—Clip-on Direct Reading Exposure Meter with case. Shpg. wt. 6 oz. . . . \$16.50
3 CA 8114—Filter Adapter. Wt. 3 oz. . . 4.89

NO MONEY DOWN on Easy Terms . . see page 63

See how easily you'll use a
precision Tower 35mm reflex

SWIFT: SURE COMPOSING



Look into brilliant viewfinder . . you see the whole 35mm frame . . watch it sharpen up as you focus lens. You can't accidentally crop picture because you actually see it.

ACCURATE EXPOSURE SETTINGS

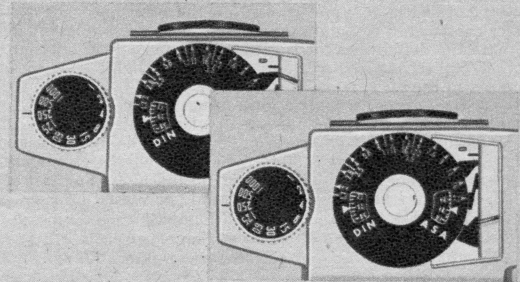

Clip-on coupled exposure meter reads directly . . needle points to exact lens opening. As you change shutter speed needle automatically shows new lens opening.

*GET SPARKLING COLOR SLIDES
CRISP BLACK AND WHITE PHOTOS*



35mm Automatic Electric Eye Cameras

Take pictures like an expert . . . no guesswork, no figuring, no setting

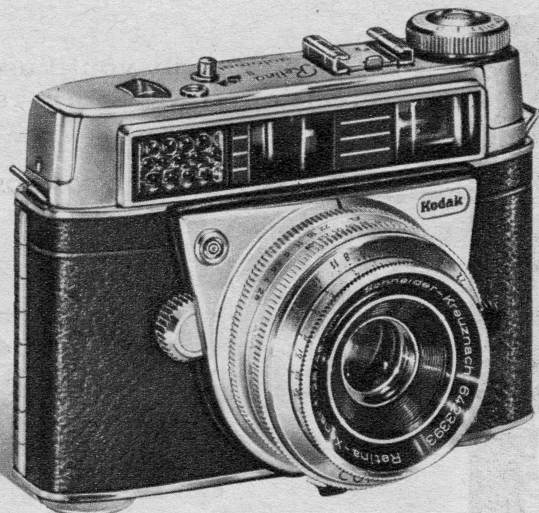

Kodak Retina Automatic III with f:2.8 lens

\$10750 NO MONEY DOWN
cash

Get automatic exposure control on the precision-made Retina. It's this simple: set camera for automatic operation. Then press release lever. Electric eye automatically determines correct lens opening at any of five shutter speeds, from 1/30 to 1/500 second. When there isn't enough light, lever locks and stop signal appears in the viewfinder.

Manual exposure control for unusual light conditions. Use film from ASA 10 to 1000. Rangefinder combined with viewfinder. Retina-Xenar f:2.8, 45mm lens. Single-stroke film advance. You never get a double exposure.

Shutter speeds from 1/30 to 1/500 and bulb. Electronic flash synchronized at all speeds, M-type at 1/30, F-type at 1/30 and 1/60. (For flash see 3 CA 8900, page 51.) All-metal, leather-covered body. Made in West Germany.

- 3 CA 7878C—Retina Automatic III. Shipping weight 3 lbs. \$107.50
- 3 CA 7879—Leather Case for above. Shipping weight 1 lb. 10.35
- 3 CA 8106—Filter Adapter. (Takes series 6 filters.) Shpg. wt. 3 oz. 2.52

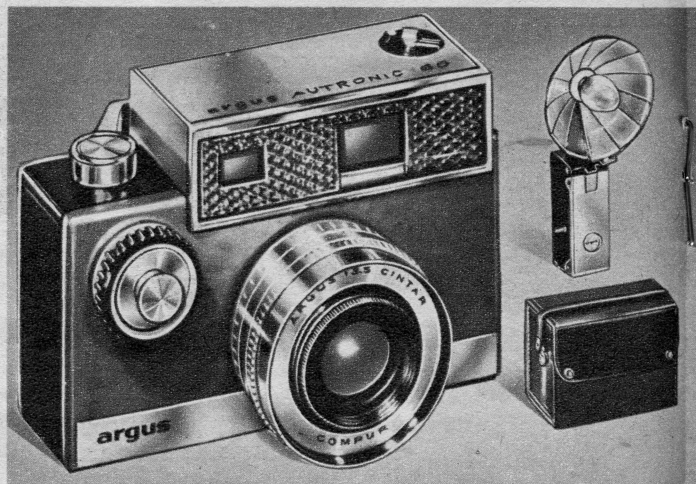

Argus Autronic Camera with f:3.5 lens, case and flash

\$8788 NO MONEY DOWN
cash

The Argus Autronic leaves nothing to chance. Just aim the camera and the sensitive built-in electric eye finds the perfect lens opening. You can set the exposure control for any film speed from ASA 10 to 200.

Famous 50mm f:3.5 Cintar lens, the same lens used on the popular C3. Set Compur shutter for speeds from 1/30 to 1/500 plus bulb for manual use. Also has simplified settings for "Flash," "Scenes," or "Action."

Focusing is easy too. Coupled rangefinder and viewfinder bring all subjects in focus from 3 ft. to infinity. Single-stroke film advance counts exposures, prevents double exposures and blanks. Built-in retaining ring, so you can use series 5 filters. Take 20 or 36 exposures with one roll of 35mm film. Synchronized for both electronic flash and flash bulbs (5 or M25).

Plug-in fan-fold flash included. Also comes with leather case. Camera has die-cast metal top, back and front.

- 3 CA 7812C—Argus Autronic Outfit. Shipping weight 4 lbs. \$87.88

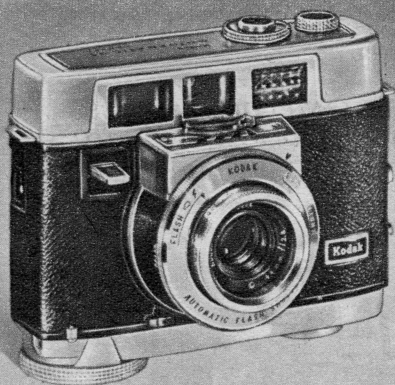

Kodak Motomatic 35

\$8833 NO MONEY DOWN
cash

Here's a 35mm camera you don't have to wind after each shot. The spring-operated drive of the Motomatic stores enough power from two windings to transport 20 pictures. Take pictures with unheard of speed—as fast as 10 in 6 seconds.

Automatic exposure control with film ASA 10 to 800. Flash exposure control. 44mm f:2.8 lens. Four shutter speeds from 1/40 to 1/250. Projected frame finder with parallax marking. Built-in adapter ring for series 5 filters. Metal body.

- 3 CA 7876C—Kodak Motomatic. Wt. 3 lbs. . . \$88.33
- 3 CA 7877—Leather Case. Shpg. wt. 1 lb. 7.95
- 3 CA 8971—Midget Flashholder. Shpg. wt. 8 oz. 3.98

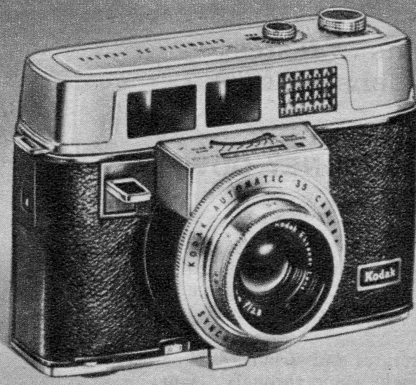

Kodak Automatic 35mm Camera

\$7222 NO MONEY DOWN
cash

Find the right lens opening the simplest way. In normal light, electric eye finds it for you. For flash, use simple manual EV system.

You get click-stop zone focusing down to 2½ ft. Warning signal in viewfinder when light is insufficient. Fast f:2.8 lens. Synchro 80 shutter. Single-stroke film advance prevents double exposures. Easy drop-in loading, automatic film leader wind-off. Takes 20 or 36 shots. Built-in series 5 filter adapter. All-metal body.

- 3 CA 7803C—Kodak Automatic. Wt. 2 lbs. . . \$72.22
- 3 CA 7804—Leather Case. Shpg. wt. 10 oz. 7.95
- 3 CA 8971—Midget Flashholder. Shpg. wt. 8 oz. 3.98

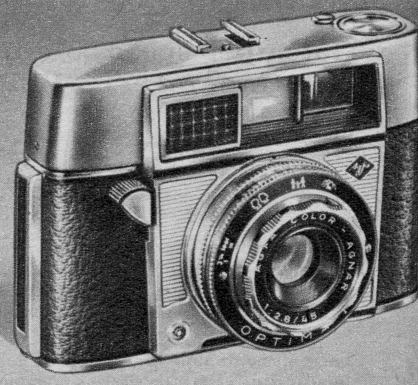

Low-priced Agfa Optima I

With case **\$7520** NO MONEY DOWN
cash

Automatic picture taking . . . set the indicator on the lens for one of three kinds of pictures . . . "Close-ups," "Groups," or "Distant Scenes."

Then electric eye sets correct lens opening. If there isn't enough light, red marker appears in the bright-frame viewfinder. In good light, marker is green . . . release shutter, get perfect picture.

F:2.8 lens. Speeds from 1/60 to 1/500. Takes films from ASA 10 to 100. All-metal body. From West Germany.

- 3 CA 7880C—Agfa Optima I, case. Wt. 4 lbs. . \$75.20
- 3 CA 8900—Flash Unit. From Japan. Wt. 8 oz. 5.75
- 3 CA 8108—Series 6 Filter Adapter. Wt. 3 oz. 2.52

NO FUSS..NO FIGURING..NO DELAY

Just aim and shoot
in sun or shade . .
Automatic Electric Eye
does the rest . .



Take it with a Tower
127 Electric Eye



Enjoy fully automatic electric eye operation
plus built-in flash at a sensationally low price

TOWER Automatic 127 \$1750

Low-cost TOWER camera is designed to give you every automatic feature found on more expensive cameras of its type plus added features not found on any camera in its price range.

Take 12 color or black and white pictures or color slides on inexpensive 127 film. Take them outdoors or indoors . . day or night-time. No extra flash gun to buy or carry. Built-in flash uses jellybean-size AG1 bulbs. Set camera to your film's speed index by sliding a lever until correct number shows in window. Take pictures in dim light with fast 3-element lens.

Focus quickly for correct distance-to-subject by simply turning lens mount to proper footage marking. Focus from 5 feet to infinity.

Remarkable photoelectric eye sets lens automatically for correct daytime exposures. When you focus for flash shots, the lens adjusts to the correct opening automatically . . no time wasted dividing distance and guide numbers.

Red signal in viewfinder tells when you need flash. Flash batteries with outfit only, otherwise order separately. Neck strap included.

3 CA 7888—Camera only. Wt. 1 lb. 8 oz. . . . \$17.50

Outfit: 3 CA 7888 camera, case, four AG1 bulbs, 1 roll black and white film, 2 penlight batteries.
3 CA 7889—Shipping weight 3 lbs. 4 oz. . . . \$19.50

AG1 Flash Bulbs. One dozen in sleeve. Shipping weight 4 ounces.

3 CA 8782—For indoor color film. Sleeve 77c

3 CA 8783—AG1B (blue) for outdoor color film when used indoors. Sleeve 89c

Penlight Batteries for flash.
3 CA 8935—Shipping weight 4 ounces. . . . 2 for 39c

Send no money . . pay later on Sears Charge Plan . . see page 63

Shoot color or black and white . . . Inexpensive Box Camera Outfits

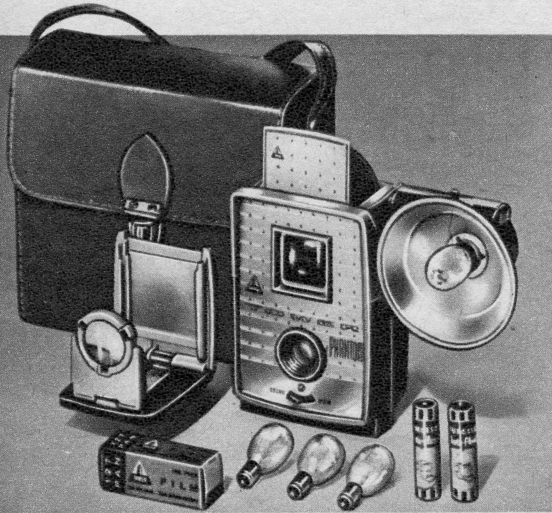

Complete TOWER Phantom Reflex Outfit

\$777

It's easy to take beautiful pictures when you can compose your scene in a bright, full-picture-size reflex viewfinder. Hood snaps shut to protect viewfinder. Take 12 sharp 3½x3½-in. pictures or 2x2-in. color super slides on 127 film. Fixed-focus lens. Switch sets lens for color or black and white film. Shoot as close as 5 ft. Take pictures indoors or at night with flash attachment. Uses M2 bulbs. Camera body of durable, high-impact plastic in pleasing, two-tone green.

You get all this in the outfit: the camera, flash attachment, 4 M2 bulbs, 2 penlight batteries, 1 roll 127 black and white film, gadget bag and 2x2-inch slide viewer.

3 CA 7946—TOWER Phantom Outfit. Shpg. wt. 1 lb. 6 oz. . . \$7.77

Just think . . . you get a TOWER Camera with built-in flash . . . all the accessories you need including a gadget bag

All for Only **\$588**

Complete Outfit with TOWER Hide Away Camera

- Cover up . . . you're ready to take indoor or outdoor flash pictures
- Cover down . . . flash stays clean and protected when not in use

For this low price you get a complete outfit that lets you shoot pictures all day . . . indoors or out. And you can take beautiful color snapshots or slides as well as sharp black and white pictures. You'll get twelve 3½x3½-inch prints or 2x2-inch color super slides on 127 film. Flash uses economical M2 bulbs.

Take pictures as close as 5 feet away to as far as the eye can see . . . fixed-focus lens makes everything sharp . . . without adjustments.

Sturdily built of high-impact plastic in attractive two-tone gray and green.

Complete outfit includes: Hide Away camera with built-in flash, adjustable neck strap, 1 roll of black and white film, 4 flash bulbs, 2 flash batteries, pocket-size slide viewer, gadget bag with shoulder strap. Packaged in attractive gift box.

3 CA 7945—Shipping weight 1 lb. 8 oz. . . \$5.88



TOWER Camflash . . . won't let you accidentally double expose

Camera Only **\$564** 11-pc. outfit **\$764**

As colorful as the slides and prints it takes. Handsome jet black, flame red or light blue colors. Almost nothing to do . . . just sight subject in bright eye level viewfinder and shoot. Built-in flash . . . no extras to carry but tiny, low-cost AG1 bulbs. Fixed focus lens. Takes 12 sparkling clear black and white or color prints, or color slides on 127 film. Sturdy plastic body. *State color.*

3 CA 7989—Outfit. Camera, case, 2 flash shields, 4 AG1 bulbs, 2 penlight batteries, 1 roll black and white film. Shpg. wt. 3 lbs. . . . \$7.64

3 CA 7988—Camflash only. Wt. 1 lb. 8 oz. 5.64

3 CA 8935—Eveready Leakproof Penlight Photoflash Battery (number 6). Use for TOWER Camflash (3 CA 7988) above. Powerful, long-lasting. Shipping weight 4 oz. 2 for 39¢

For AG1 Flash Bulbs, see page 47



TOWER Pixie . . . compact . . . yet flash built in

8-pc. outfit **\$477**

You'll be ready for those extra special picture taking events. Bright eyelevel viewfinder makes aiming and composing easy. Nothing to attach . . . flash built right in. Take snapshots or slides . . . shoot indoors or out. 12 exposures on 127 film. Sturdy plastic body, fixed focus lens. Outfit includes Pixie camera with built-in flash, 4 AG1 flash bulbs, 2 penlight batteries, plus roll of black and white film.

3 CA 7949—Pixie Flash Outfit. Shpg. wt. 2 lbs. \$4.77

3 CA 7948—Pixie Camera only. Shpg. wt. 1 lb. 8 oz. 3.77

Why Guess? Exposure Meters mean better pictures



Get accurate readings in poorest light

\$895

When you're taking pictures in extremely dim light, where many meters will not register at all, flip out booster cell of this TOWER meter for ultrasensitive readings. Easy match-the-needle operation. Use with any type of camera (still, movie or polaroid) with black and white or color film.

Sensitive, complete, yet priced low. EV scale (2 to 19) for Polaroid cameras. ASA-rated film scale reads speeds from 6 to 12,000. Calibrated for exposures from f:1.4 to f:32. Simplified dial gives readings from 8 to 1/2000 second. When you take movies, use special scale with settings from 8 to 64 f.p.s. Durable plastic construction. Comes with leather case, neck cord and instructions. Expertly made in Japan.

3 CA 8879—Shipping weight 12 ounces.....\$8.95



Complete readings without attachments . . use Our Best Meter

\$1250

Avoid incorrect exposures, the most common cause of poor pictures. Easy-to-use TOWER light meter helps insure perfect exposure.

You get correct camera settings for black and white or color film, with still or movie cameras. Separate movie scale, 8 to 64 f.p.s. Measures reflected or incident light. Color finder helps judge color content of light. Adjustable scales for ASA film speeds from 6 to 1600, at all shutter-lens combinations from 8 seconds to 1/500 second, "f" stops f:1.4 to f:45, plus LVS system (1 to 19) for Compur shutters. Complete, accurate readings without

accessories. Translucent roller blind protects photoelectric cell and glass-covered dial face. Sturdy plastic case. Also has film-speed memo chart on back, plus chrome-plated clip-on chain. Quality crafted in West Germany. Compare with more expensive meters to see its great value! Instructions included.

3 CA 8889—Meter. Shpg. wt. 8 oz.....\$12.50
3 CA 8862—Leather Case. Wt. 4 oz..... 1.23

Do you have enough film? See our complete selection on pages 65, 67

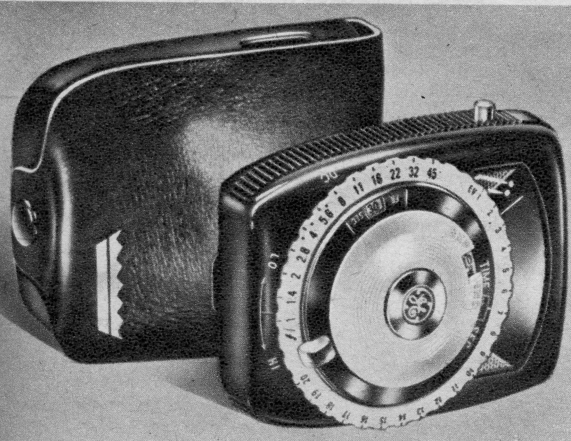

Find correct exposure for fastest films

\$2995 NO MONEY
cash DOWN

No film too fast, no light too dim when you use the General Electric PR3. Film indexes from ASA .1 to 20,000. Shutter speeds from 120 to 1/32,000 second, "f" stops from f:1 to f:45. Red fluorescent pointer gives exact lens setting. Quick, easy to use. Set film index and shutter speed, aim and press the button—all in 5 seconds! Lock-button "remembers" reading. Land settings 1 to 9, EV settings (LVS) from 1 to 20. Movie settings 8 to 128 frames per second. Black plastic case, gold-color trim. Leather case, neck cord and instructions included.

X3 CA 8873—Meter with case. Shipping weight 1 lb.....\$29.95

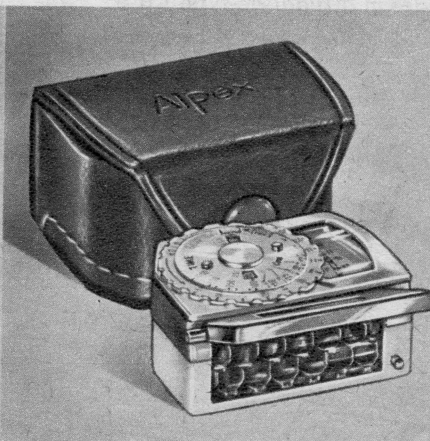

Add Clip-on Meter to camera

\$695

Clip meter directly onto camera. Built-in adjustable accessory shoe fits all cameras with accessory clips. Compact meter includes most features found on full-size models. Film scale from ASA 6 to 6400, "f" readings f:1 to f:45. Handles shutter speeds from 1 second to 1/1000. Also use meter with Polaroid or movie cameras. Sealed photocell. Metal and plastic body. Leather case included. From Japan.

3 CA 8865—Meter and case. Wt. 8 oz....\$6.95



Light Meter built for movies

\$477

Make sure of perfect exposure for your color movies. Direct-reading meter. See exposure shown in "f" stops at standard 16 frames per second speed. Calibrated for exposures from f:1.9 to f:16 for both indoor and outdoor Kodachrome. Photoelectric cell gives completely accurate light readings. Plastic body. Leather case, neck cord. Made in Japan.

3 CA 8892—Shipping weight 8 oz....\$4.77

Do you have your "Charge Account" at Sears yet? See page 63

TOWER Films..for natural color

Tower Slide Film gives you processed and mounted color slides for 9¢ each...less than a black and white print.

Tower Color Movie Film with processing costs 29% less than any other color movie film Sears has ever sold.

Sears laboratory has tested Tower film and we believe no film gives more brilliant color or sharper detail.

YOUR CHOICE

Titler, Splicer or Reel with every roll of

TOWER Movie Film ordered

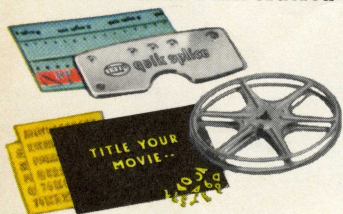

Stock up on those handy movie accessories you've been wanting and get them at no extra cost with each roll of movie film you order.

Titler Set has 120 letters plus background board (choice of A—black; B—red, or C—blue board).

Splicing Kit with metal template, 10 splicing strips.

Metal Reel holds 200 ft. of film.

HOW TO ORDER: State catalog number of film and accessory wanted and state "no charge" for accessory.

35mm Color Slide Film with processing

20 exposures \$1.99

Now you can enjoy the rich, breath-taking beauty of color slides at less than the cost of black and white snapshots. Each 20-exposure roll includes the cost of processing and mounting. Color slides can be seen in a hand viewer or projected big as life on a screen for the entire family to enjoy. Beautiful color prints can also be made from them.

Outdoor TOWER film has a rating of ASA 10, indoor ASA 16. Shipping weight 3 ounces.

3 CA 7123—Daylight 35mm, processing included.....\$1.99
3 CA 7122—Indoor 35mm, processing included..... 1.99

8mm Color Movie Film plus accessory choice

With processing 25-ft. roll \$2.39

Relive all the exciting action and color of vacations, family picnics, parties and other memorable events through TOWER color movies. Even at this low price choose any accessory at left with each roll you buy. Every 25-ft. roll yields 50 ft. of finished film ready to show. Daylight: 10. Indoor: 16.

3 CA 7121—Daylight 8mm, with processing. Wt. 4 oz....\$2.39
3 CA 7120—Indoor 8mm, with processing. Wt. 4 oz..... 2.39

3 CA 9365—TOWER Titler Set. State set A, B or C. Wt. 3 oz..89¢
3 CA 9323—Metal Reel holds 200 ft. film. Shpg. wt. 6 oz..39¢
3 CA 9371—Dry Splicer with 10 strips. Shpg. wt. 2 oz....89¢



Compare Sears Low Prices on Kodak Color Film with Processing



8mm Kodachrome with processing

\$3.44

25-ft. roll type



35mm Kodachrome with processing

\$2.99

20-exposure regular

When you order Kodak color film with processing, your photofinisher is as close as your mailbox. You'll receive a return mailing bag to hold exposed roll. Just mail it. Your slides will be returned postpaid by first class mail.

Film	Film size	Type	Catalog Number	Shpg. wt.	Price
Film with processing					
Regular Kodachrome in sizes for most 8mm and 16mm movie and 35mm still cameras... choose from daylight or indoor types. Gives brilliant color reproduction... keeps details sharp. Make lifelike slides and movies you'll show with pride. Exposure index: daylight ASA 10, indoor ASA 16.	35mm (20 exp.)	Daylight	3 CA 7094	3 oz.	\$2.99
	35mm (20 exp.)	Indoor	3 CA 7062	3 oz.	2.99
	35mm (36 exp.)	Daylight	3 CA 7095	3 oz.	4.88
	35mm (36 exp.)	Indoor	3 CA 6778	3 oz.	4.88
	8mm 25-ft. roll	Daylight	3 CA 7102	4 oz.	3.44
	8mm 25-ft. roll	Indoor	3 CA 7143	4 oz.	3.44
	8mm 25-ft. magazine	Daylight	3 CA 7103	4 oz.	4.79
	8mm 25-ft. magazine	Indoor	3 CA 7104	4 oz.	4.79
	16mm 50-ft. magazine	Daylight	3 CA 7131	4 oz.	7.95
	16mm 50-ft. magazine	Indoor	3 CA 7178	8 oz.	7.95
16mm 100-ft. roll	Daylight	3 CA 7139	8 oz.	9.55	
16mm 100-ft. roll	Indoor	3 CA 7145	8 oz.	9.55	
Film without processing					
828 Bantam	Daylight	3 CA 7025	3 oz.	79¢	
828 Bantam	Indoor	3 CA 7026	3 oz.	79¢	
Film with processing					
New Kodachrome II. 2½ times faster than regular Kodachrome. Index: daylight 25, indoor 40.	35mm (20 exp.)	Daylight	3 CA 7161	3 oz.	\$3.77
	35mm (20 exp.)	Daylight	3 CA 7162	3 oz.	5.77
	8mm 25-ft. roll	Daylight	3 CA 7163	4 oz.	4.77
	8mm 25-ft. roll	Indoor	3 CA 7164	4 oz.	4.77
Ektachrome. A fast, high-quality film that gives you slides with colors that are pleasingly pastel. Gives fine detail with a minimum of grain. Exposure index: daylight 32, indoor 16.	35mm (20 exposures)	Daylight	3 CA 6772	3 oz.	\$2.99
	35mm (20 exposures)	Indoor	3 CA 6776	3 oz.	2.99
	127	Daylight	3 CA 6781	3 oz.	2.49
	127	Indoor	3 CA 6780	3 oz.	2.49
	120	Daylight	3 CA 6774	3 oz.	2.49
	120	Indoor	3 CA 6782	3 oz.	2.49
High Speed Ektachrome. Fastest color film. Exposure index: daylight 160, indoor 125.	35mm (20 exposures)	Daylight	3 CA 6965	4 oz.	\$3.49
	35mm (20 exposures)	Indoor	3 CA 6992	4 oz.	3.49

Prices above include quality TOWER processing except Kodachrome 828 Bantam is sold without processing

Now, buy Kodacolor Film (for snapshots) with processing included in price of film



That's right, price now includes everything... the film... developing the negatives... and processing into beautiful oversize color prints.

Here's what you do: Shoot the film, secure it in mailing bag, send it to nearest TOWER Color Service listed on facing page. You'll receive your prints by return first class mail.

Remember, Kodacolor makes color snapshots or enlargements. It does not make transparencies (color slides) like Kodachrome. Index: daylight 32, indoor 25.

Price includes processing

Catalog No.	Size	Exposure	Wt.	Price
3 CA 7206	620	8...	5 oz.	\$3.20
3 CA 7209	620	12...	5 oz.	3.89
3 CA 7217	120	8...	5 oz.	3.20
3 CA 7218	120	12...	5 oz.	3.89
3 CA 7207	127	8...	5 oz.	3.20
3 CA 7216	127	12...	5 oz.	3.89

Enlargements and Prints from Kodacolor negatives

Kodacolor print sizes: 3½x3½ inches from 127, 120 and 620 film (12 exposures); 3½x5 inches from 116, 616, 127, 120 and 620 film (8 exposures); 2½x3½ inches from 35mm and 828 bantam film. Kodacolor negatives give beautiful prints. State number of prints from each negative. Standard Oversize Prints... 29¢ Prints from 35mm, 828... 20¢

Standard 5x7 and 8x10-inch Enlargements make excellent gifts. Order three 5x7 enlargements from the same film and save! 5x7-in. Ea. \$1.25 Three 5x7-in. from same film \$2.99 8x10-in. Ea. \$2.99

Special-size Enlargements. Order when subject won't fit a standard size above. From 616 or 116 negatives, 4x7 and 6x10-inch enlargements instead of 5x7 or 8x10. From 620, 120 or 127 negatives, 7x10-inch enlargements. From square negatives, 5x5 and 8x8 inch, instead of 5x7 or 8x10 inch. Enlargements 4x7 or 5x5... \$1.25 Enlargements 6x10, 8x8 or 7x10. \$2.99

See How to Order TOWER Color Film Service on facing page. Include check or money order. No C.O.D.'s or charges.

CPBKM AEDSLG SEARS 67

Less than \$40 buys an Automatic 35mm Camera your whole family can use



Shoot in brilliant sun . . . on hazy days . . . on dull days
Electric eye sets lens correctly . . . gets perfect pictures every time



TOWER Automatic 35mm Camera with built-in flash

Without case **\$39⁴⁷** **NO MONEY DOWN**
cash

- Highly polished reflector-type flash gives maximum output from tiny, low-cost AG1 flash bulbs
- Compact automatic 35mm camera measures just 5½x2½x3½ in., a delight to hold . . . quick to sight . . . convenient to carry

Electric eye automatically sets lens for light condition whether you shoot color or black and white film . . . even warns when light's too dim. One lever advances film, counts exposures, prevents double exposures. Special control for backlight and manual exposure settings 4 shutter speeds . . . 1/40 to action stopping 1/250 second. Easy, zone-type focusing. 48mm f:3.8 lens is sharp from 3 ft. to infinity. ASA film settings 10 to 200. Flash shield. Metal body. From Japan.
3 CA 7839—Camera. Batteries, bulbs sold separately. Wt. 3 lbs. . . \$39.47
3 CA 7838—Black Cowhide Eveready Case. Shipping weight 1 lb. 5.23
3 CA 8059—Series 5 Filter Adapter. Shpg. wt. 1 oz. 2.19
3 CA 8935—2 Penlight Batteries. Shipping weight 4 oz. 2 for 39c

Just tap the bar or push a button to show slides automatically



Push-button remote control puts complete slide show command in the palm of your hand

500-watt TOWER 75 Projector

With remote control **\$66⁴⁹** **NO MONEY DOWN** Without remote control **\$57⁷⁷**
cash cash

- Remote control automatic . . . exceptionally low priced . . . and it operates automatically 2 ways
- You'll enjoy the convenience of continuous slide showings using TOWER hook-together 40-slide trays. And with 3-way editor, actually arrange slides during show

Compact, easy-to-use 35mm projector makes slides "come alive" on your screen in glowing, detailed beauty. Powerful blower protects slides . . . keeps them in focus. Unique 3-way editor lets you 1) load slides while projecting, 2) preview single slides, 3) rearrange slides during show. 3-position switch controls lamp, blower, off. Room lamp control turns lamp off at start of show . . . on when completed.

Sharp, micro-focusing 5-in. f:3.5 lens. Takes all types of 2x2-in. slides in same tray (one 40-slide tray included). Slide counter. Rapid manual tray advance, also reverse. Self-contained case. Ruggedly built. Metal and plastic body with red, gold color trim. 110-120-volt, 60-cycle AC only. UL listed.

- 3 CA 9877K—Projector with remote control. Shpg. wt. 23 lbs. . . . \$66.49
- 3 CA 9875C—Projector only (no remote control). Shpg. wt. 18 lbs. 57.77
- 3 CA 9876—Remote Control. Fits 3CA9875C projector. Wt. 2 lbs. 8 oz. 9.49
- 3 CA 8627—Extra Lamp for projector. Shpg. wt. 6 oz. 4.49



NO MONEY DOWN on Easy Terms . . . see page 63

CPBKMAEDSLG